

# Biomedical Instrumentation I

## Lecture-6: The Heart & Electrocardiogram (ECG)

**Dr Muhammad Arif, PhD**

[m.arif@faculty.muet.edu.pk](mailto:m.arif@faculty.muet.edu.pk)

<https://sites.google.com/site/mdotarif/teaching/bmi>

# Lecture Outline

- **The Heart**
- **The Heart as a Pump**
- **Blood Flow Cycle**
- **Electrical System of the Heart**
- **Heart Dipole**
- **Einthoven Triangle**
- **The Electrocardiogram (ECG)**
- **The standard 12 Lead ECG System**
- **Electrocardiography**
- **Types of ECG Recorders**
- **Cardiac Rhythms - Normal & Abnormal**
- **Block Diagram of ECG System**
- **Frequent Problems in ECG System**
- **ECG Artefacts**
- **Cardio Tachometer**
- **ECG Telemetry System**

# The Heart

Copyright © The McGraw-Hill Companies, Inc. Permission required for reproduction or display.

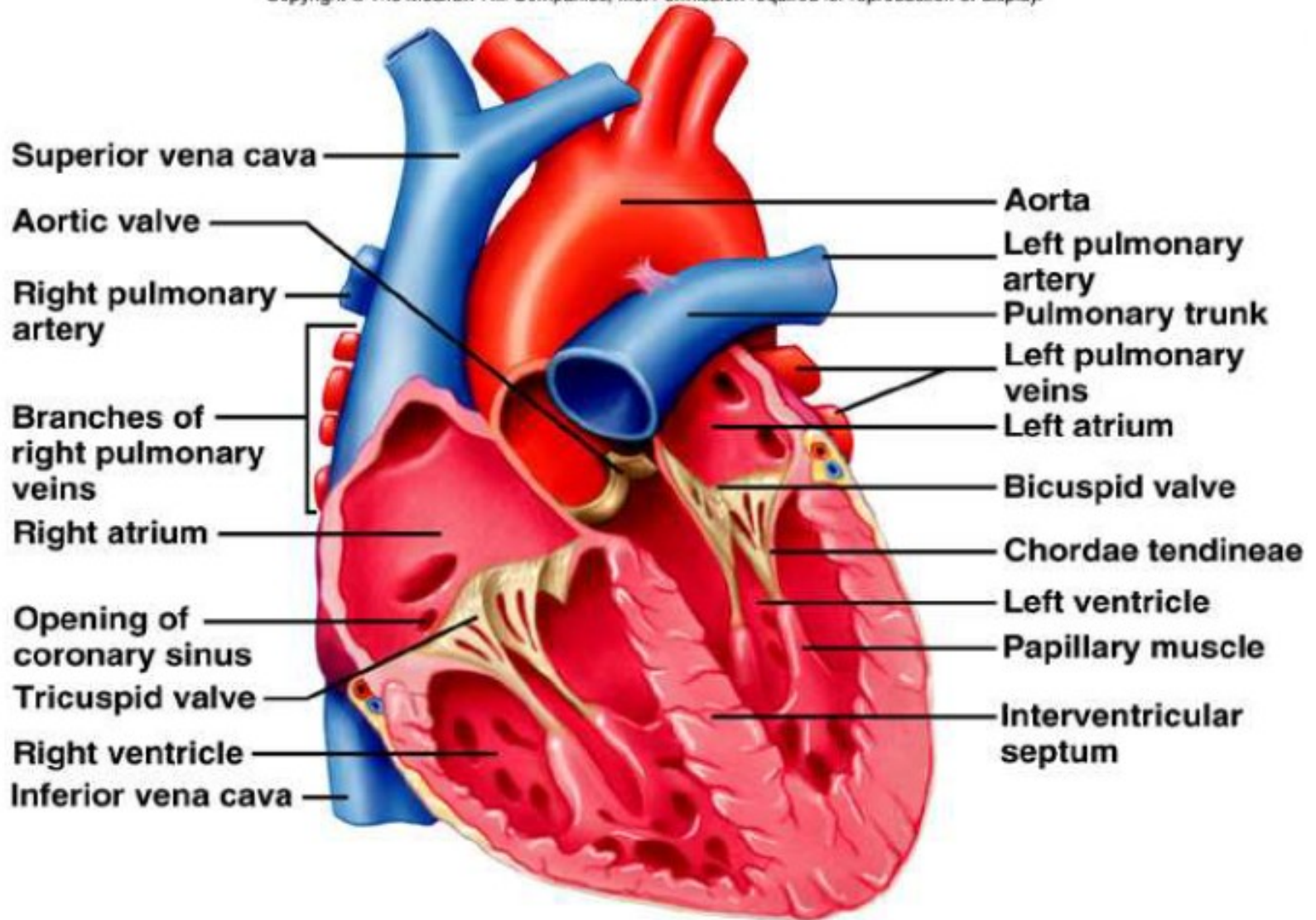

# The Heart as a Pump

Copyright © The McGraw-Hill Companies, Inc. Permission is required for reproduction or display.

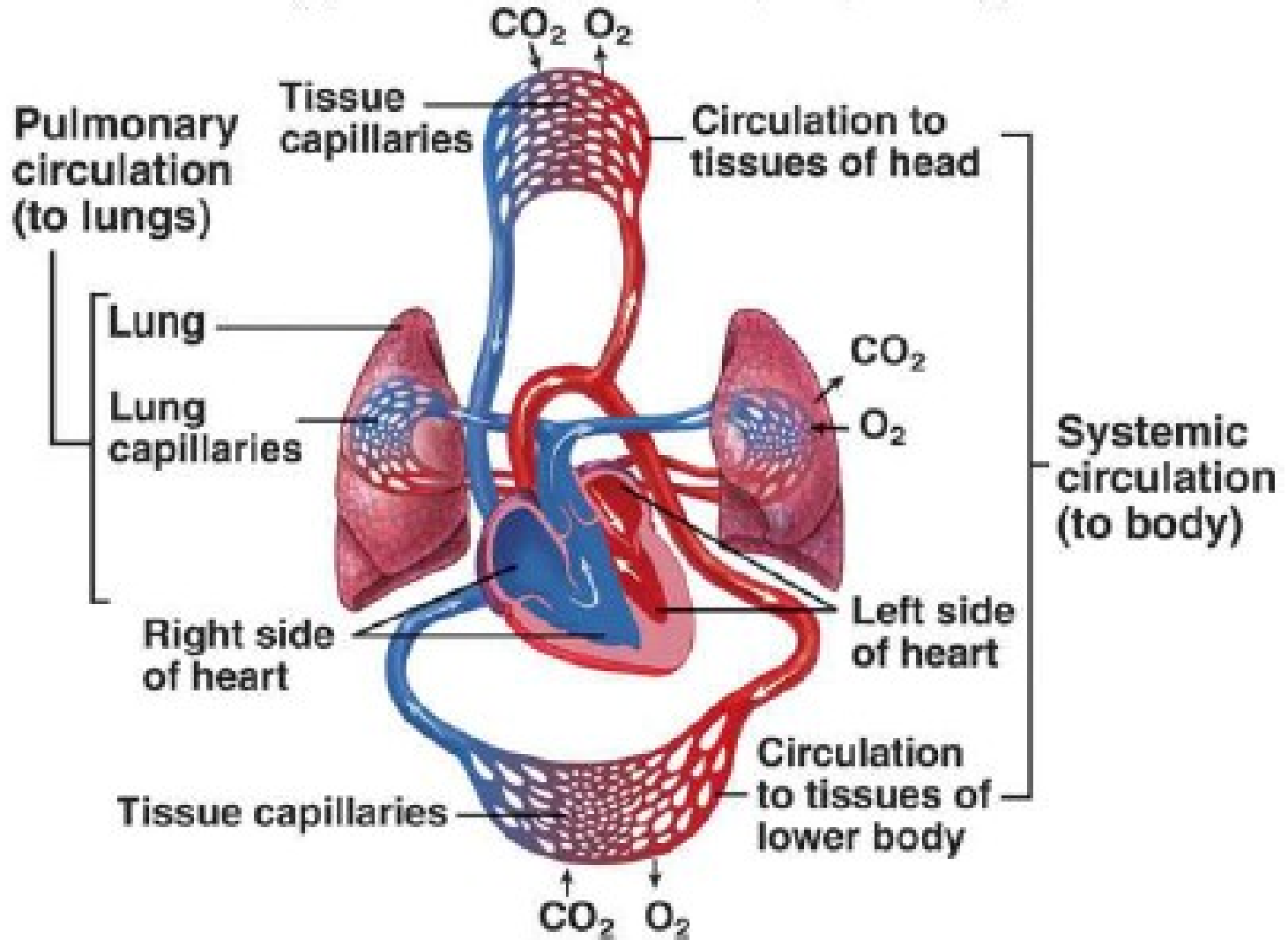

# The Heart as a Pump

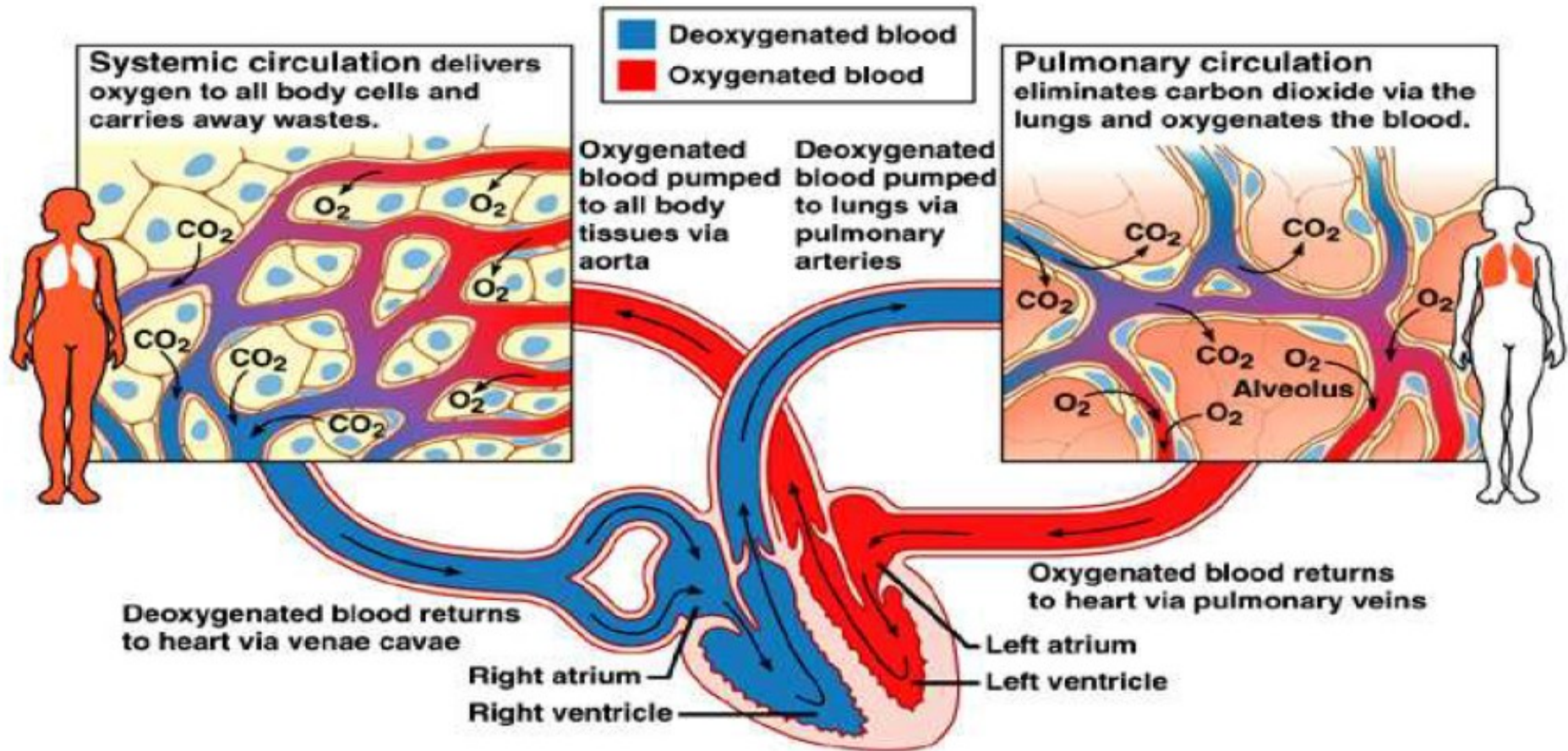

# The Heart as a Pump

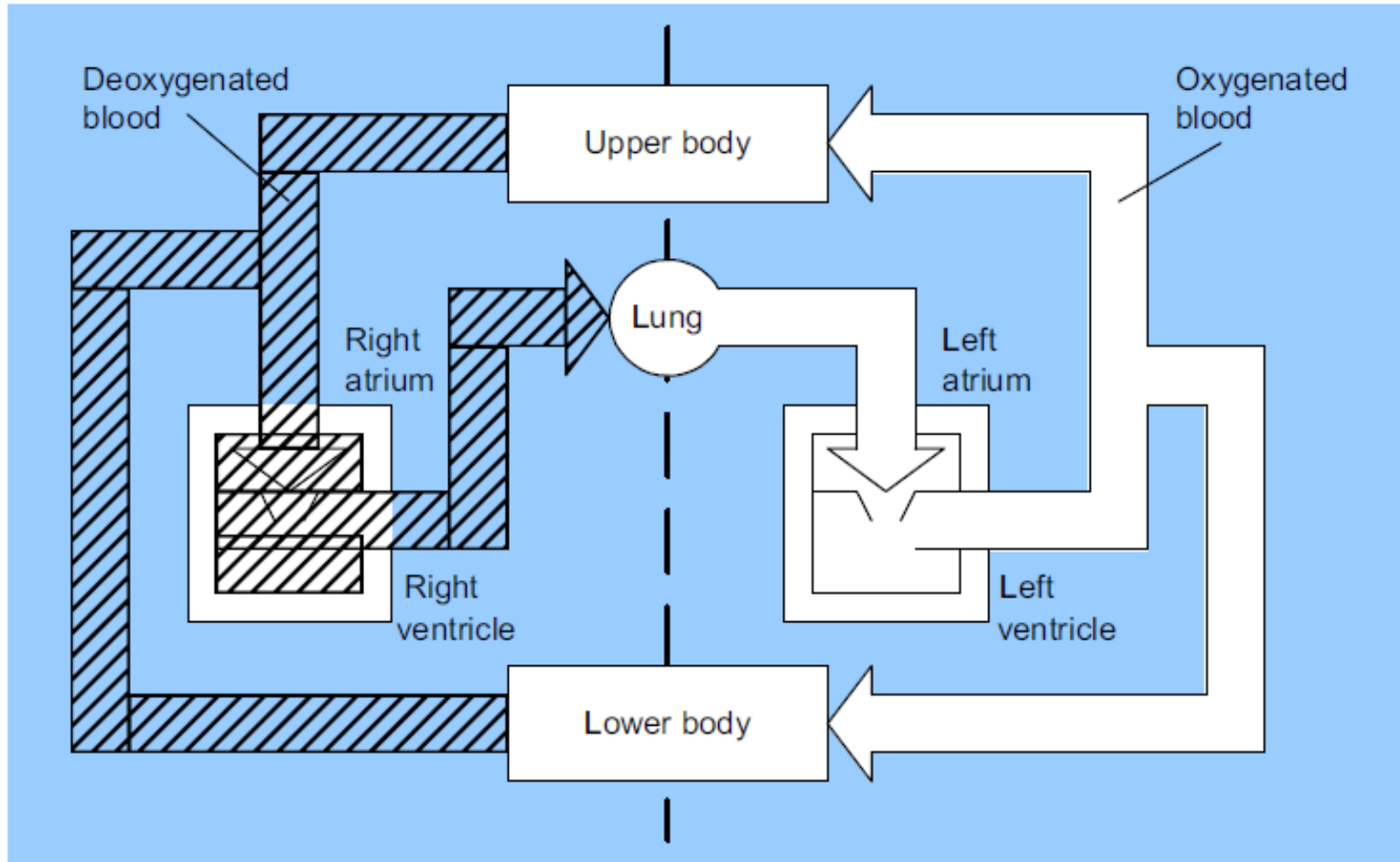

**Figure: The simplified circulatory system. The blood is delivered from the right ventricle to the lung. The oxygenated blood from the lung is then returned to the left atrium before being sent throughout the body from left ventricle. Deoxygenated blood from the body flows back to the right atrium and the cycle repeats.**

# Blood Flow Cycle

Copyright © The McGraw-Hill Companies, Inc. Permission required for reproduction or display.

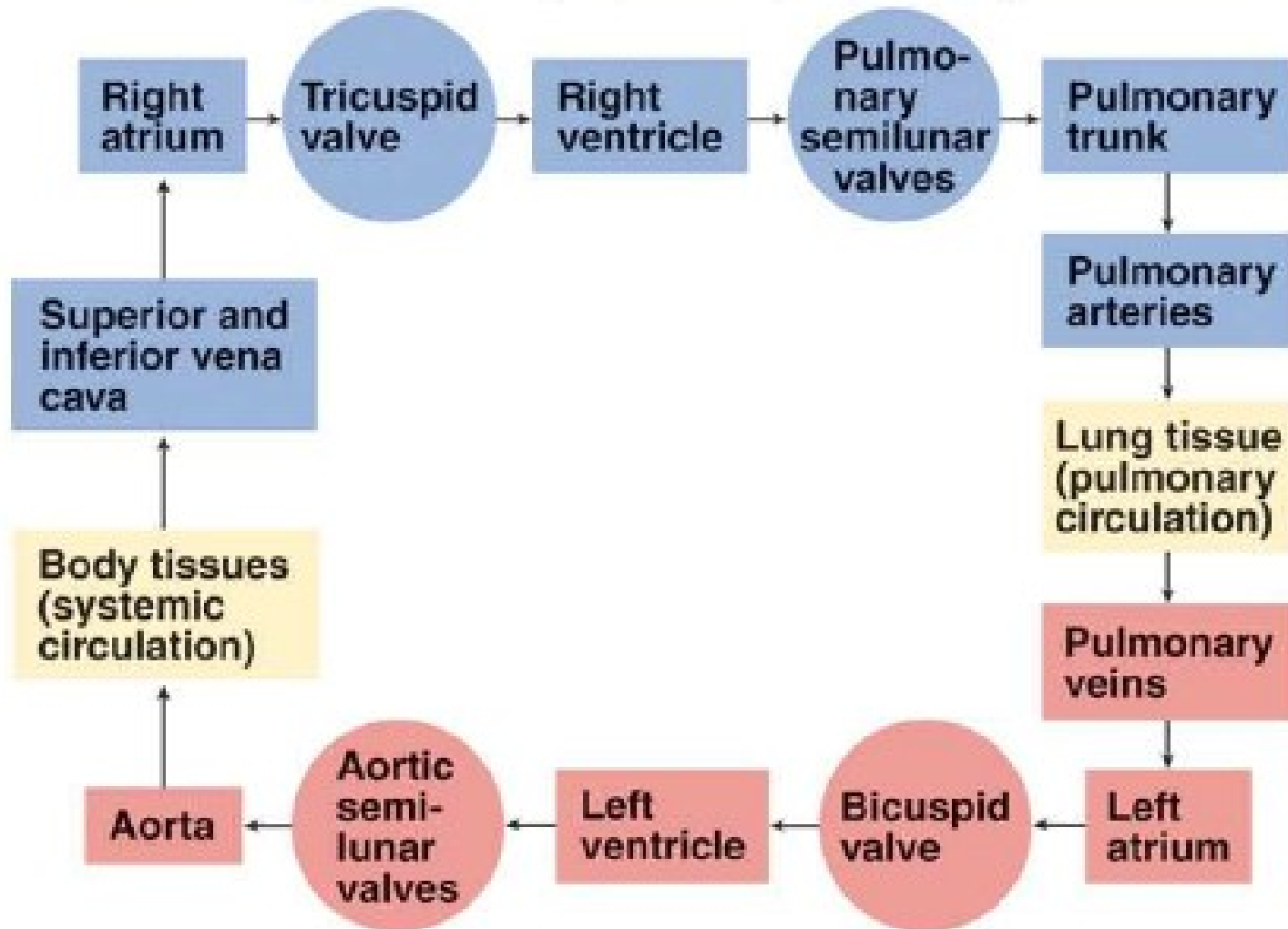

# Cardiac Cycle

Copyright © The McGraw-Hill Companies, Inc. Permission required for reproduction or display.

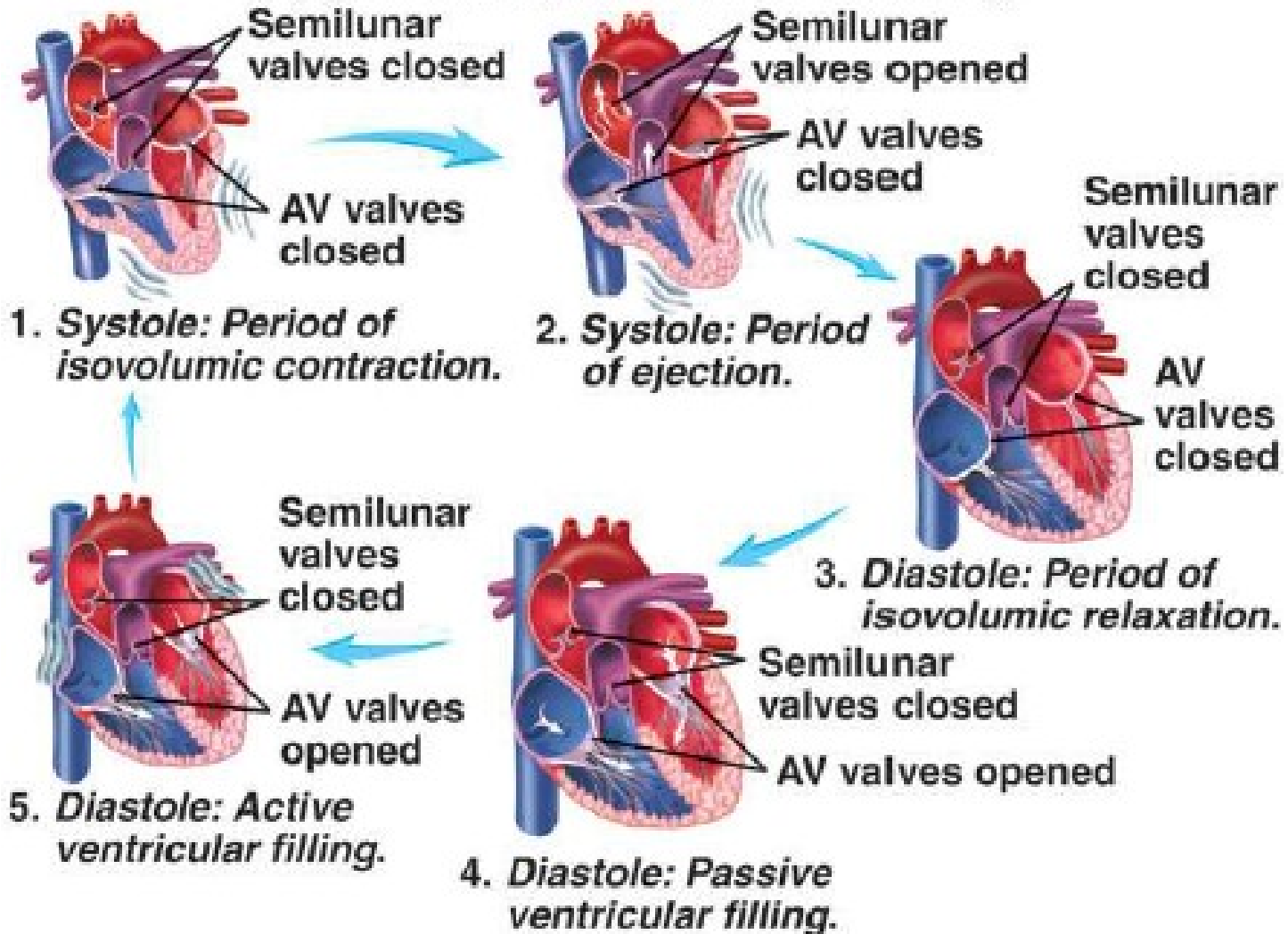



# The Heart

Copyright © The McGraw-Hill Companies, Inc. Permission required for reproduction or display.

Atrial systole	Atrial diastole		Atrial systole	Atrial diastole
Ventricular diastole	Ventricular systole	Ventricular diastole	Ventricular systole	Ventricular diastole

Pressure changes

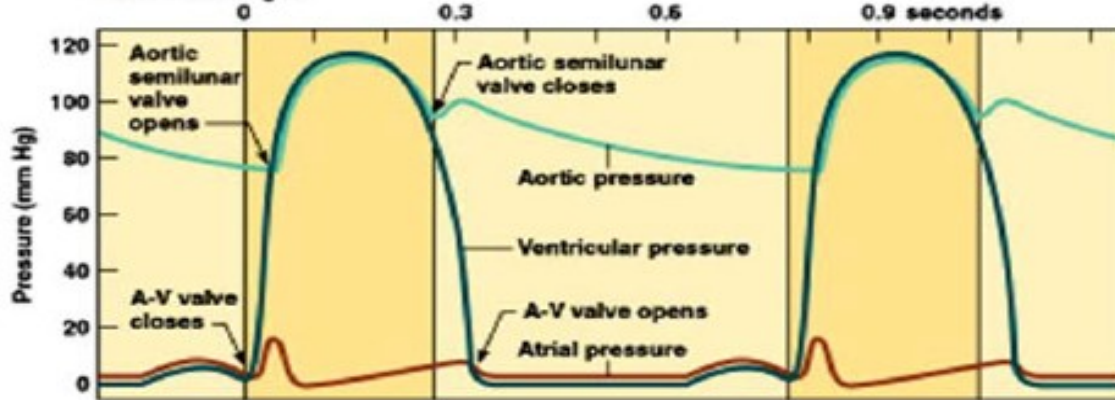

Ventricular volume

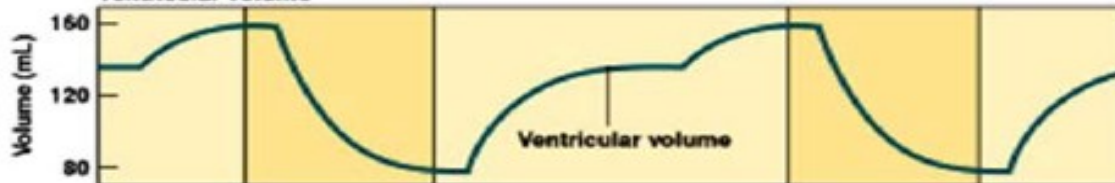

Electrocardiogram (ECG)

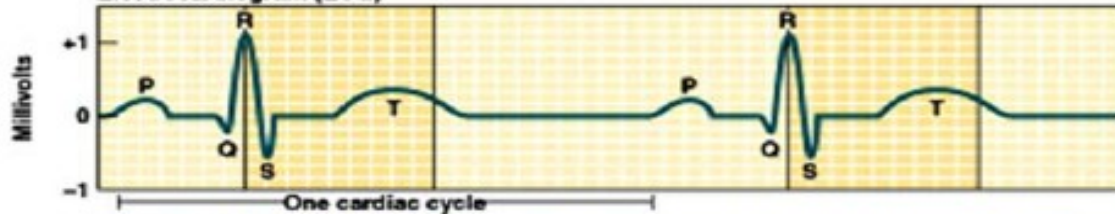

Heart sounds



# Electrical System of the Heart

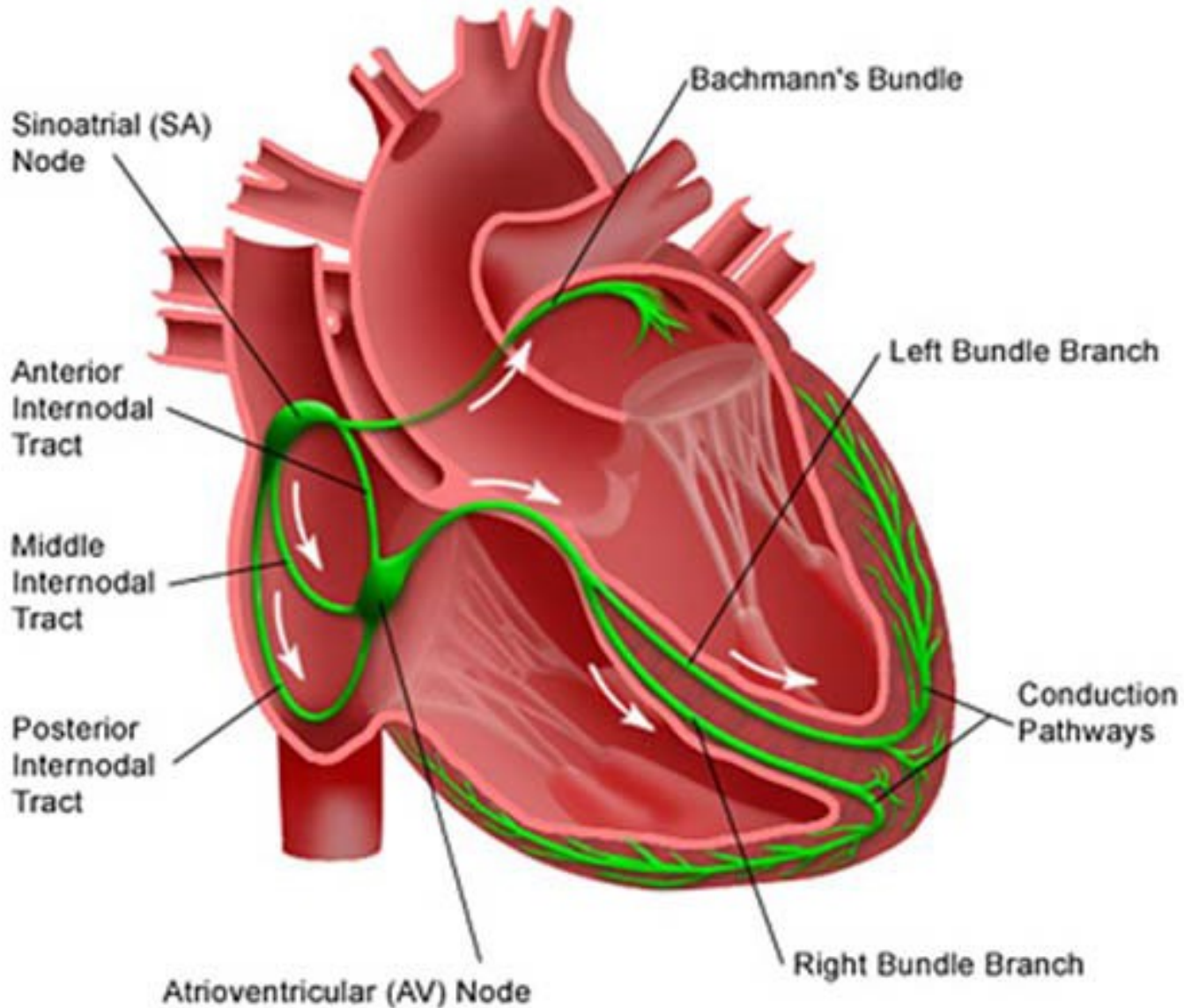

# Electrical System of the Heart

- Distribution of specialized conductive tissues in the atria and ventricles, showing the impulse-forming and conduction system of the heart.
- The rhythmic cardiac impulse originates in pacemaking cells in the sinoatrial (SA) node, located at the junction of the superior vena cava and the right atrium.
- Note the three specialized pathways (anterior, middle, and posterior internodal tracts) between the SA and atrioventricular (AV) nodes.
- Bachmann's bundle (interatrial tract) comes off the anterior internodal tract leading to the left atrium.
- The impulse passes from the SA node in an organized manner through specialized conducting tracts in the atria to activate first the right and then the left atrium.

# Electrical System of the Heart

- Passage of the impulse is delayed at the AV node before it continues into the bundle of His, the right bundle branch, the common left bundle branch, the anterior and posterior divisions of the left bundle branch, and the Purkinje network.
- The right bundle branch runs along the right side of the interventricular septum to the apex of the right ventricle before it gives off significant branches.
- The left common bundle crosses to the left side of the septum and splits into the anterior division (which is thin and long and goes under the aortic valve in the outflow tract to the anterolateral papillary muscle) and the posterior division (which is wide and short and goes to the posterior papillary muscle lying in the inflow tract).

# Electrical System of the Heart

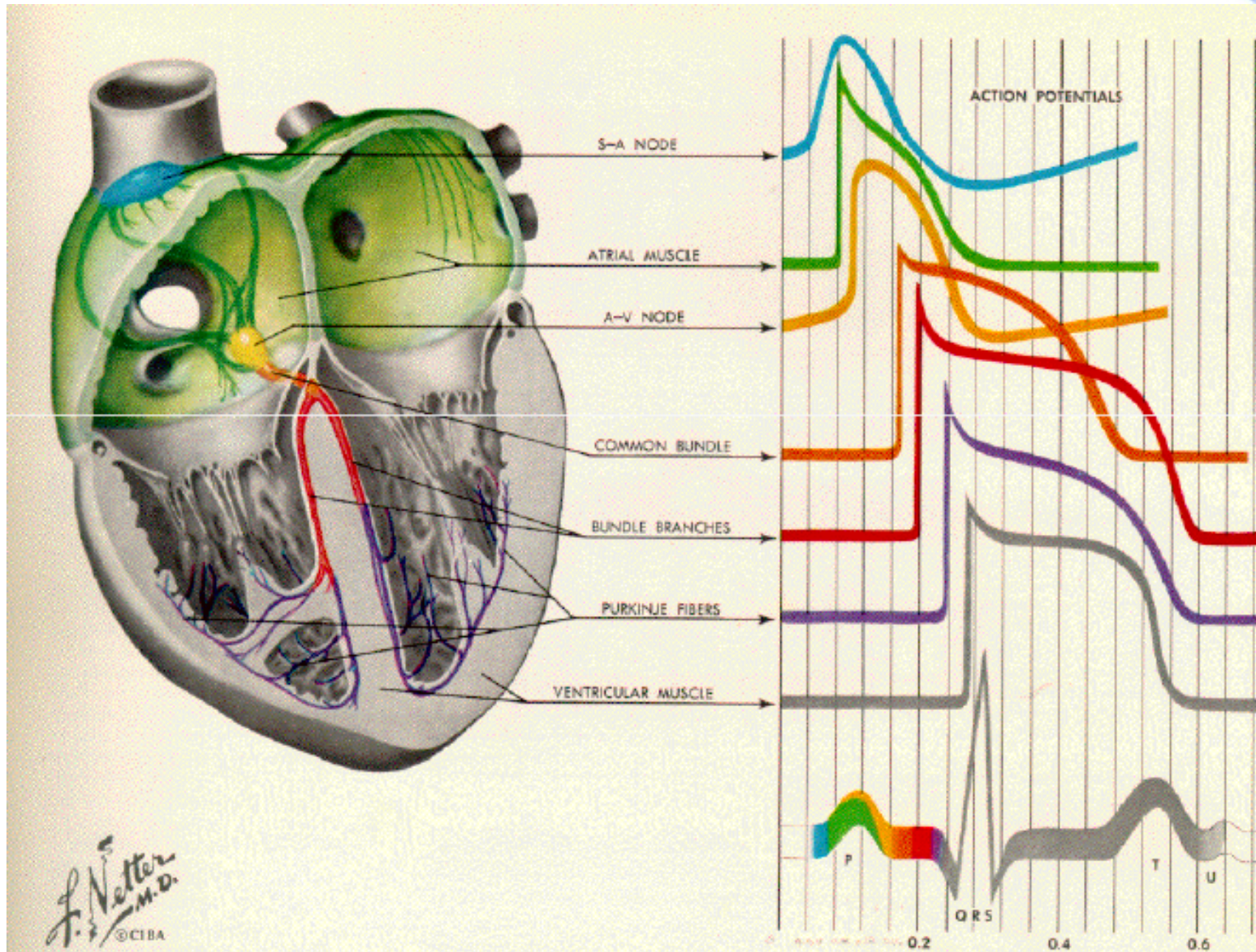

# Electrical System of the Heart

Location in the heart	Event	Time [ms]	ECG-terminology	Conduction velocity [m/s]	Intrinsic frequency [1/min]
SA node	impulse generated	0		0.05	70-80
atrium, Right	depolarization *)	5	P	0.8-1.0	
Left	depolarization	85	P	0.8-1.0	
AV node	arrival of impulse	50	P-Q interval	0.02-0.05	20-40
	departure of impulse	125			
bundle of His	activated	130		1.0-1.5	
bundle branches	activated	145		1.0-1.5	
Purkinje fibers	activated	150		3.0-3.5	
endocardium					
Septum	depolarization	175	QRS	0.3 (axial)	
Left ventricle	depolarization	190		-	
epicardium	depolarization	225		0.8	
Left ventricle	depolarization	250		(transverse)	
Right ventricle					
epicardium					
Left ventricle	repolarization	400	T	0.5	
Right ventricle	repolarization				
endocardium					
Left ventricle	repolarization	600			

# Electrical System of the Heart

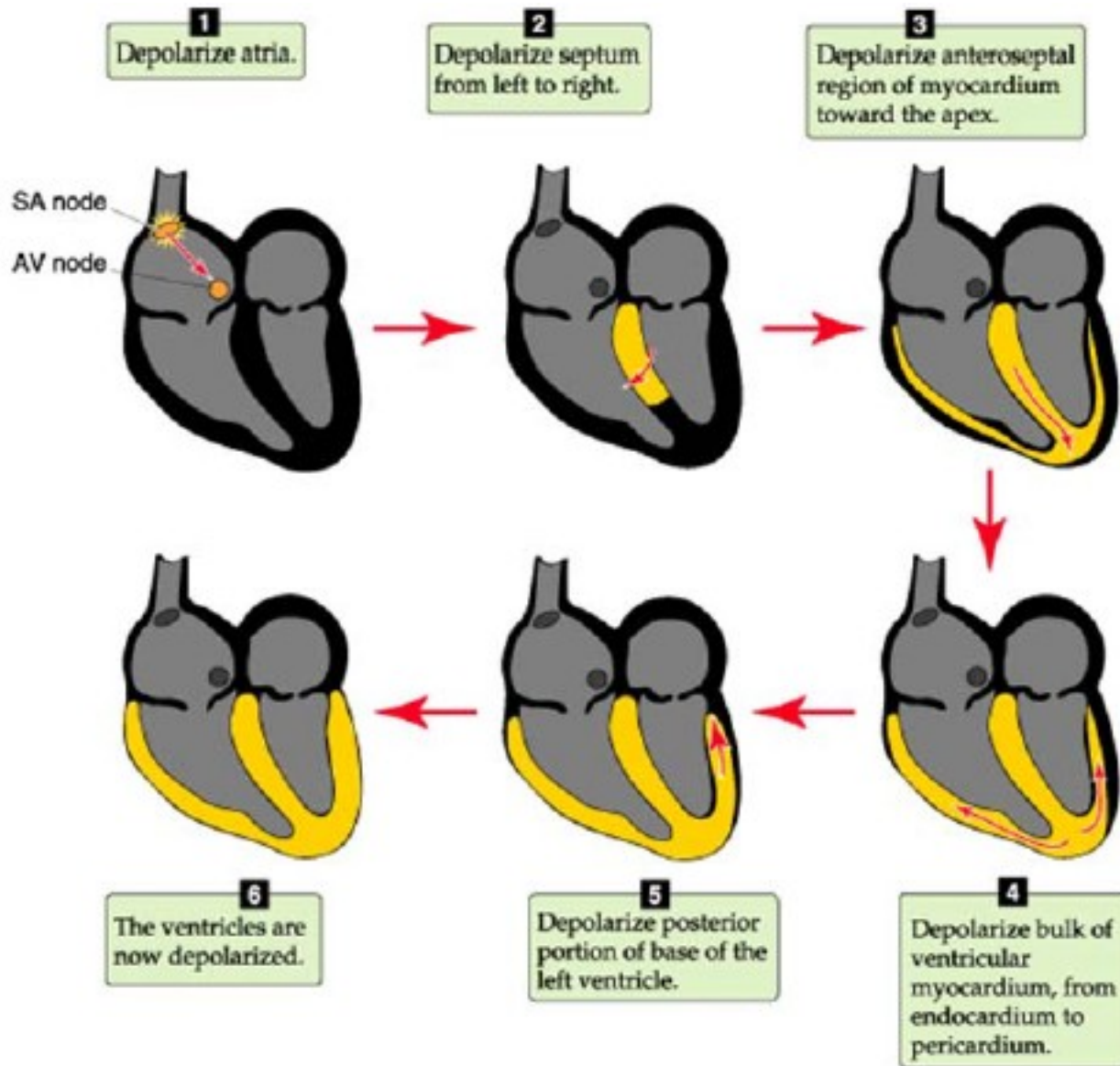

# Heart Dipole

- Heart considered as an electrical equivalent generator.
- The electrical activity represented by net equivalent current dipole located at the electrical centre of the heart.
- The electrical activity of the heart can be modelled with a vector quantity: an electric dipole, **M** whose magnitude and direction changes in time. Also called the **cardiac vector**.

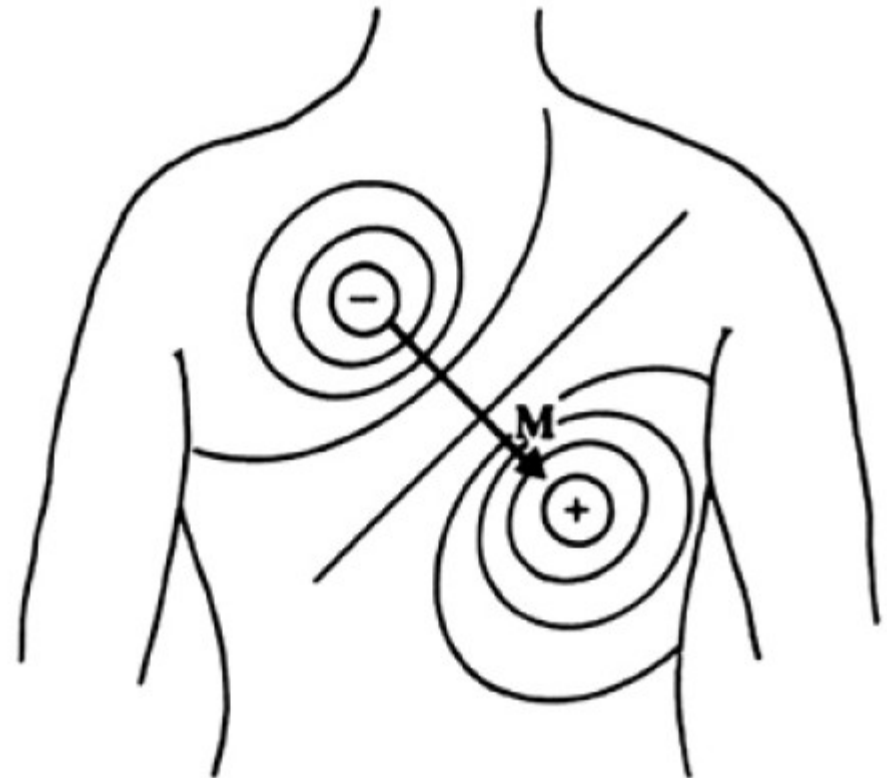
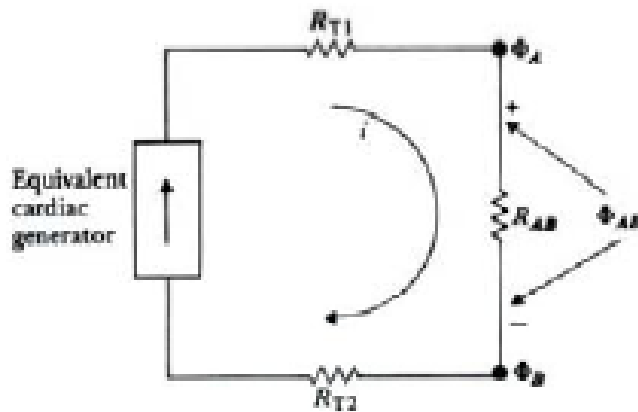
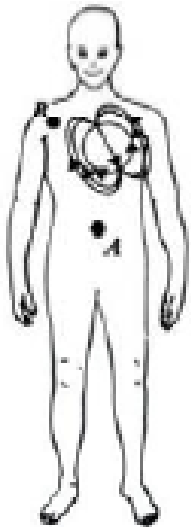



# Vector Algebra

A vector that connects a lead electrode pair is the **lead vector**.

If the cardiac vector **M** is known, the voltage generated at any lead can be easily computed.

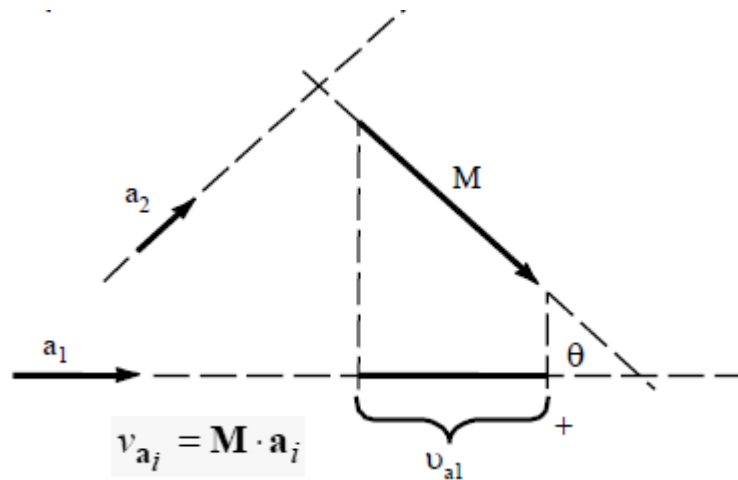

**Figure 6.2** Relationships between the two lead vectors  $\mathbf{a}_1$  and  $\mathbf{a}_2$  and the cardiac vector  $\mathbf{M}$ . The component of  $\mathbf{M}$  in the direction of  $\mathbf{a}_1$  is given by the dot product of these two vectors and denoted on the figure by  $v_{a_1}$ . Lead vector  $\mathbf{a}_2$  is perpendicular to the cardiac vector, so no voltage component is seen in this lead.

# Einthoven Triangle

- Three vectors used to fully identify the electrical activity.
- Approximation of lead vectors of limb leads.
- Determines electrode placement for ECG.
- Vector shown in frontal plane of the body.

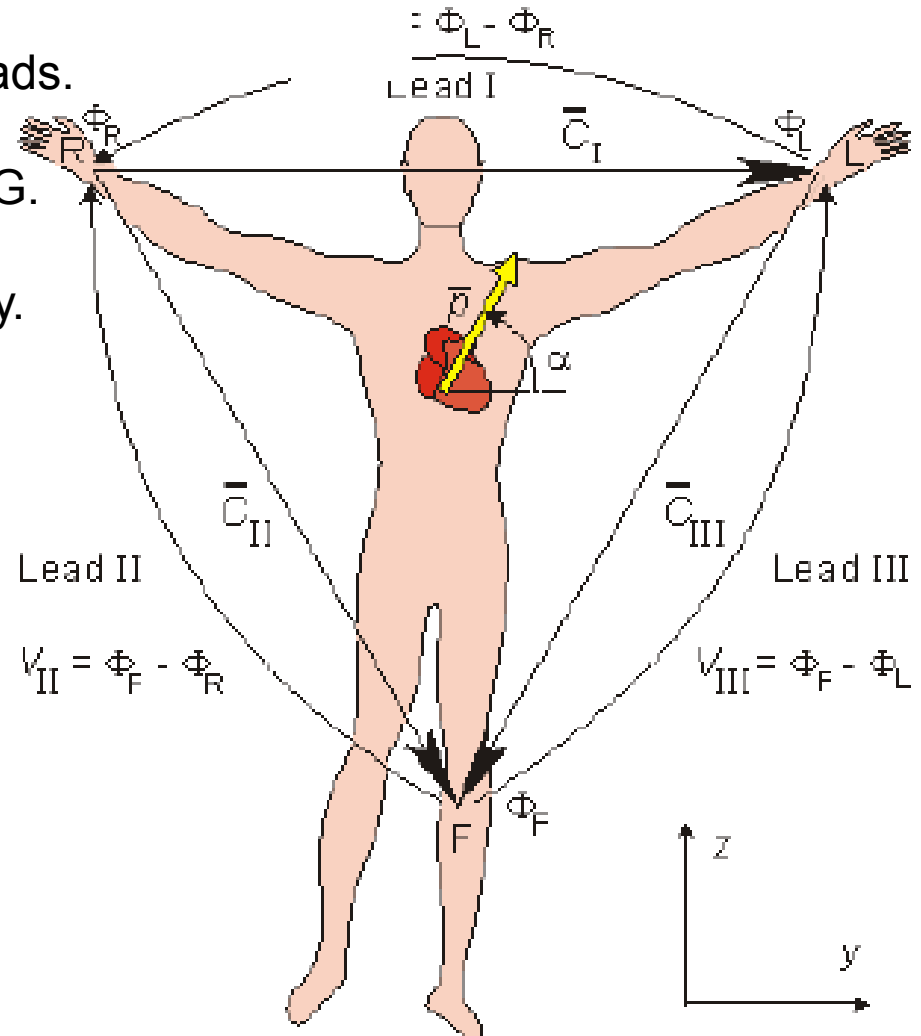

# Einthoven Triangle

Kirchhoff's law is used for the three leads

$$I - II + III = 0$$

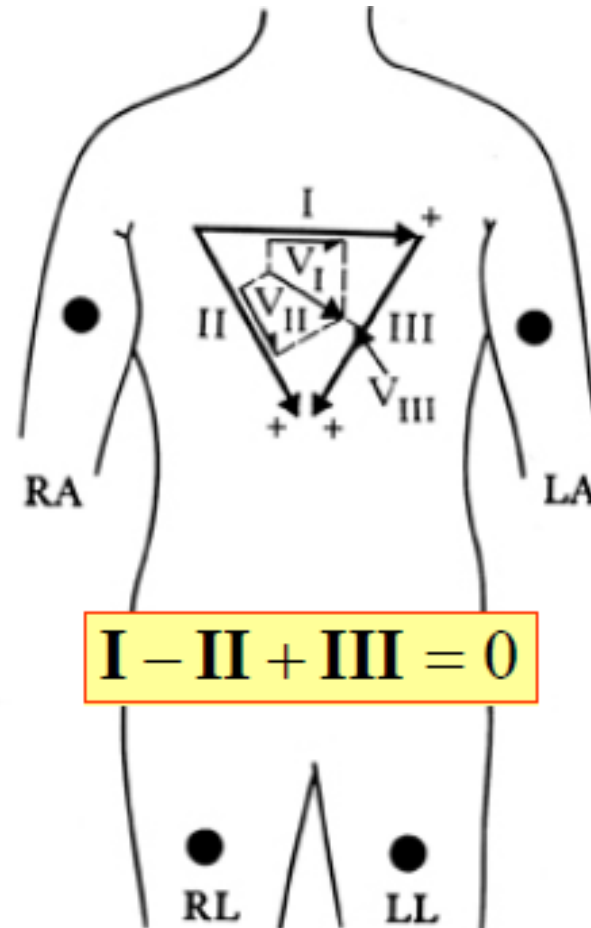

**Figure 6.3** Cardiologists use a standard notation such that the direction of the lead vector for lead I is  $0^\circ$ , that of lead II is  $60^\circ$ , and that of lead III is  $120^\circ$ . An example of a cardiac vector at  $30^\circ$  with its scalar components seen for each lead is shown.

# Einthoven Limb Leads

1



APICAL DEPOLARIZATION 230ms

LEFT VENTRICULAR DEPOLARIZATION 240ms

LATE LEFT VENTRICULAR DEPOLARIZATION 250ms

VENTRICLES DEPOLARIZED 350ms

VENTRICULAR REPOLARIZATION 450ms

VENTRICLES REPOLARIZED 600ms

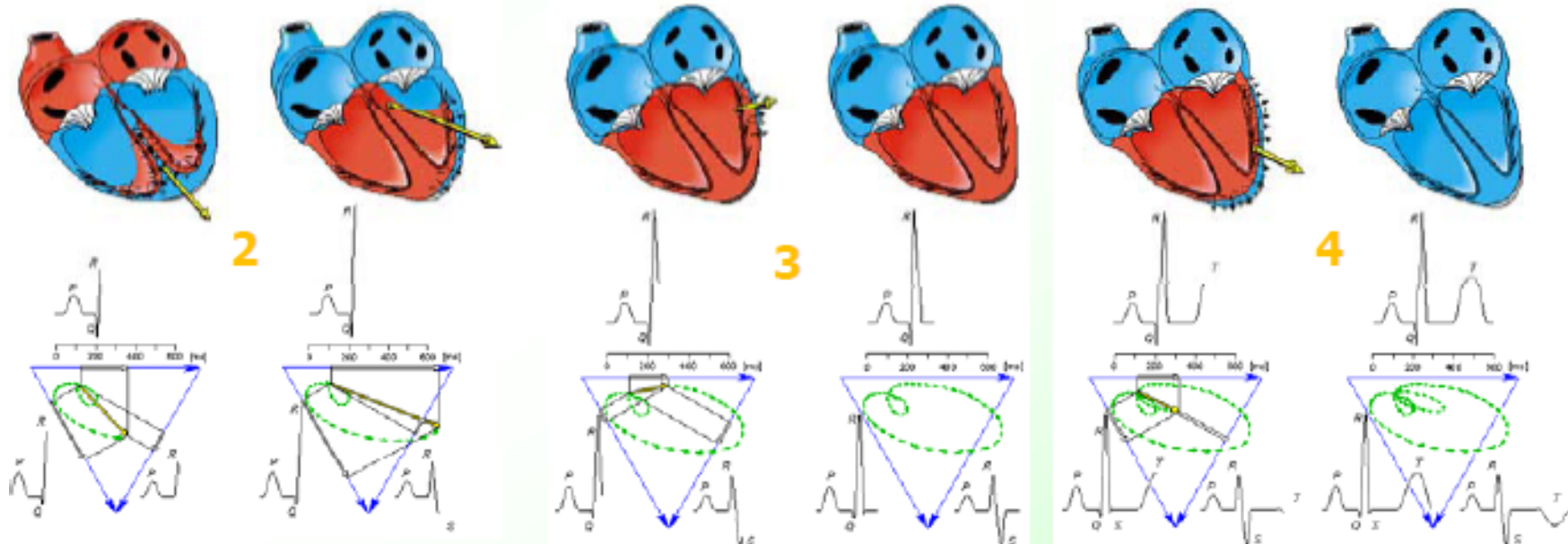

# The Electrocardiogram (ECG)

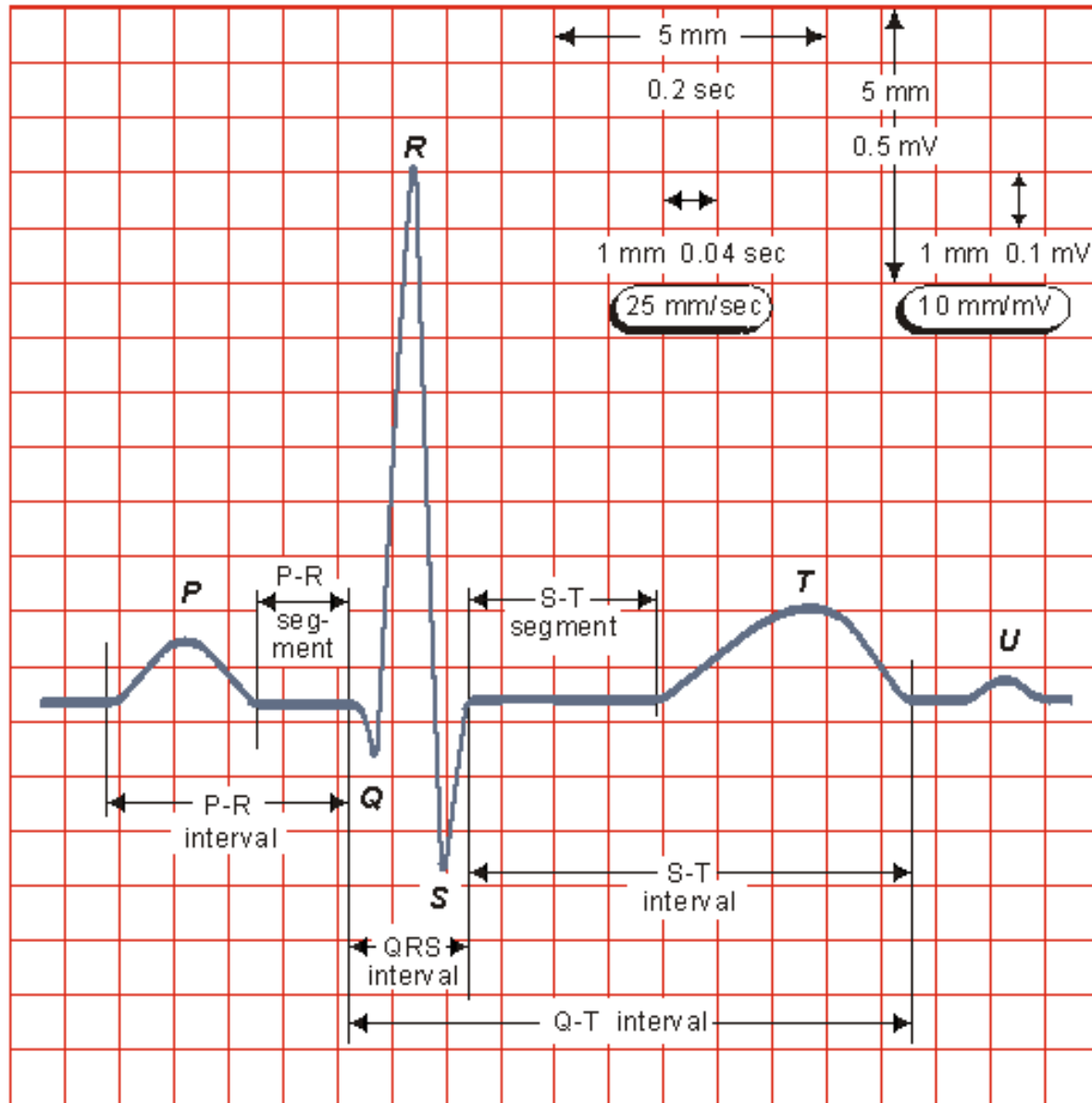

# The Electrocardiogram (ECG)

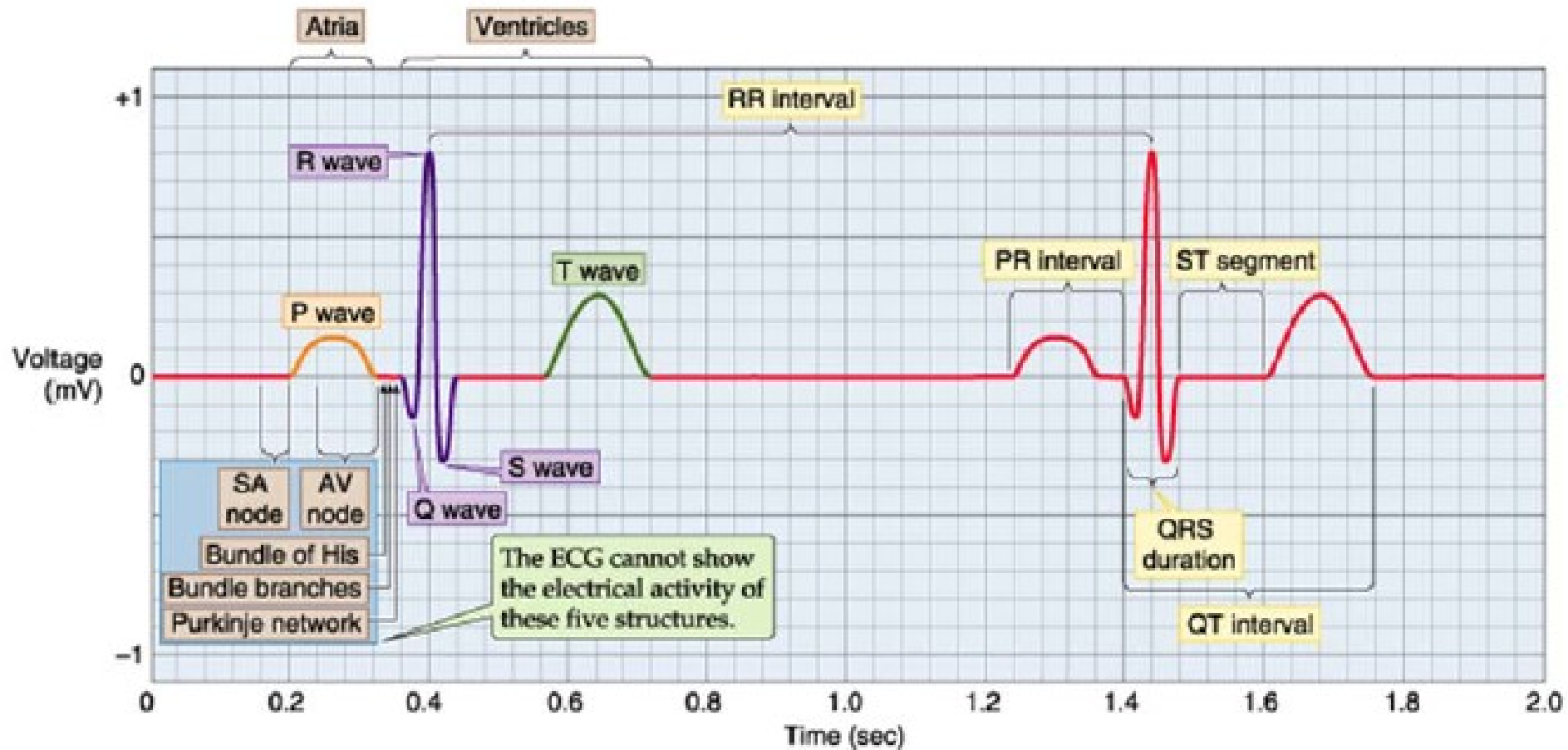

# The Electrocardiogram (ECG)

Action potential to the heart starts at the sinoatrial or SA node and it travels through the heart with delay at each point. ECG represents superposition of all signals.

**P wave** – depolarization of atria

**QRS complex** – depolarization of ventricular muscle and repolarization of atria

**T wave** – repolarization of ventricular muscle

**U-wave** – if present, believed to be the after potentials in the ventricular muscles.

**P-R interval** – is caused by delay in the AV node

**S-T segment** – is related to the average duration of the plateau regions of the individual ventricular cells.

# The Electrocardiogram (ECG)

- The electric potentials generated by the heart appear throughout the body and on its surface.
- The electrical signals of the Cardiac Conduction System can be picked up with sensors on the chest.
- These signals result in an ECG, or electrocardiogram (in Germany EKG).
- Different pairs of electrodes at different locations generally yield different voltages because of the spatial dependence of the electric field of the heart.
- This graph is frequently used to detect normal heart function.
- The familiar ECG is a reading of the different electrical signals that go off.
- The chart to the right explains the electrical significance of the different spikes in potential.



# The Electrocardiogram (ECG)

## The ECG Leads vs. Electrodes

- **Leads** are made of a combination of electrodes that form imaginary lines in the body along which the electrical signals are measured.
- A pair of electrodes, or a combination of several electrodes through a resistive network that gives an equivalent pair is called a **lead**.
- Each lead will be assigned with an axis and each of the axes will have an orientation: by convention the sense of the axis is toward the positive electrode.
- The projection of the cardiac vectors as function of time on the axis corresponding to a lead is actually the ECG trace in that particular lead.

# The Electrocardiogram (ECG)

## Abbreviations and Color Codes for ECG Electrodes

- Chest Electrode (C): **Brown**
- Right Arm (RA): **White**
- Left Arm (LA): **Black**
- Left Leg (LL): **Red**
- Right Leg (RL): **Green**

# The Electrocardiogram (ECG)

## The standard 12 Lead ECG System

**3** Standard Limb Leads

**3** Augmented Limb Leads

**6** Precordial Leads

- 6 limb leads – define electrical activity in frontal plane.
- 6 precordial leads – define electrical activity in transverse plane.

# The Electrocardiogram (ECG)

## The standard 12 Lead ECG System

	Limb Leads	Precordial Leads
Bipolar	I, II, III (standard limb leads)	-
Unipolar	aVR, aVL, aVF (augmented limb leads)	V <sub>1</sub> -V <sub>6</sub>

# The Electrocardiogram (ECG)

## The standard 12 Lead ECG System

	Positive electrode	Negative electrode
<i>Standard limb leads</i>		
Lead I	Left arm	Right arm
Lead II	Left leg	Right arm
Lead III	Left leg	Left arm
<i>Augmented unipolar leads</i>		
aVL	Left arm	All other limbs
aVR	Right arm	All other limbs
aVF	Left leg	All other limbs
<i>Precordial (chest) leads</i>		
V1–V6	Corresponding chest electrode	“Common terminal” of all the limb electrodes

# The Electrocardiogram (ECG)

## The standard Bipolar Limb Lead

- **Lead I:** LEFT ARM (LA) and RIGHT ARM (RA)
- **Lead II:** LEFT LEG (LL) and RIGHT ARM (RA)
- **Lead III:** LEFT LEG (LL) and LEFT ARM (LA)

Note: In standard bipolar limb lead system, four electrodes are placed on the limbs. However the electrode on the right leg is used for ground reference.

# The Electrocardiogram (ECG)

## The standard Bipolar Limb Leads

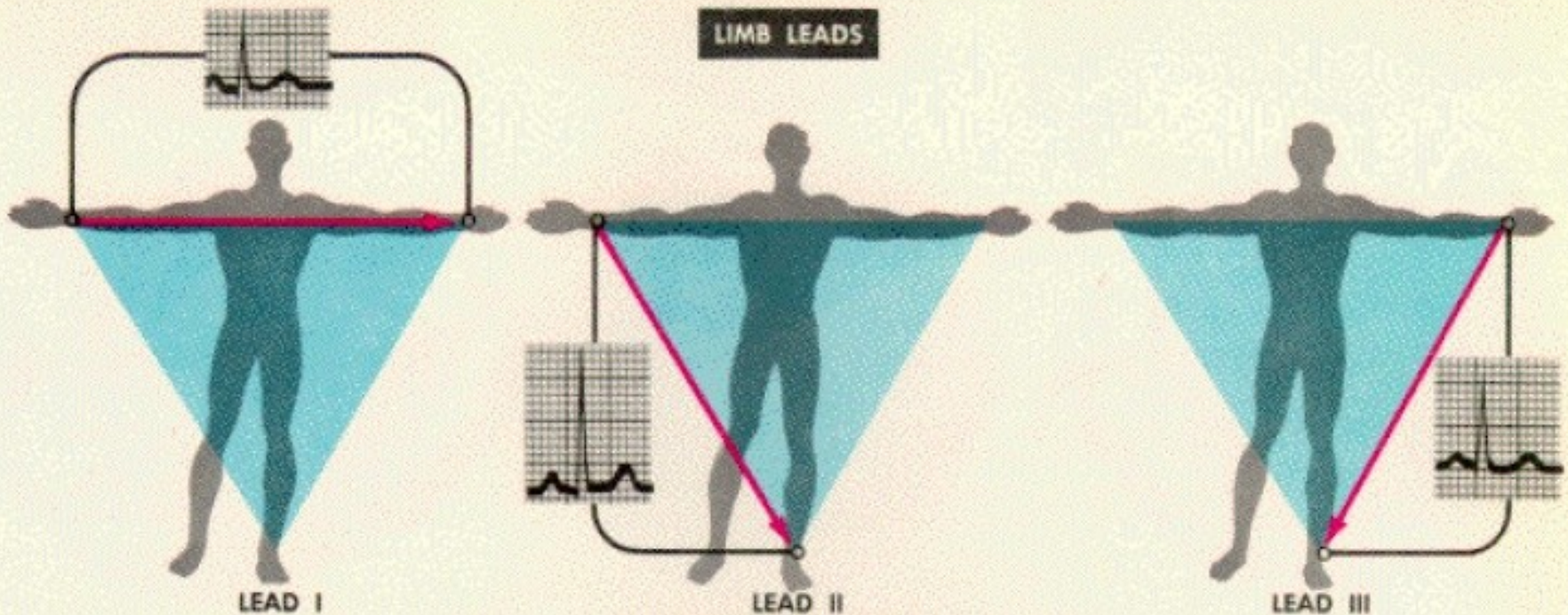

# The Electrocardiogram (ECG)

## The standard Bipolar Limb Leads

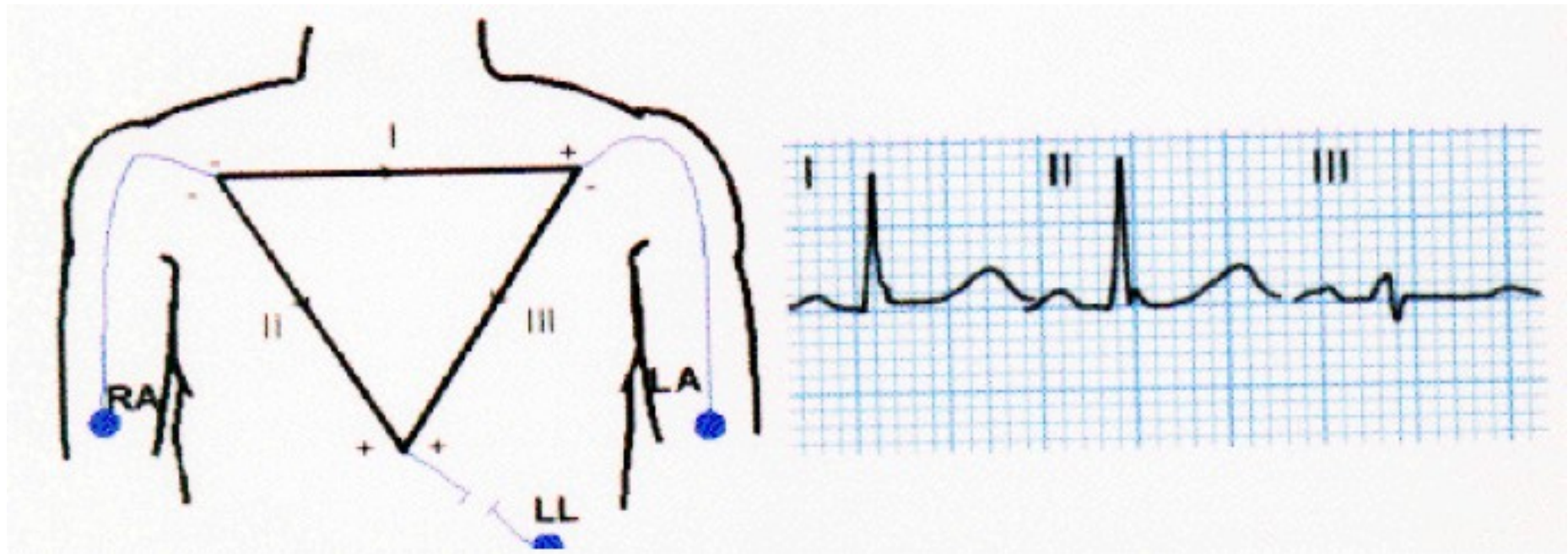



# The Electrocardiogram (ECG)

## The standard Bipolar Limb Lead

- The three bipolar limb lead selections first introduced by Einthoven.
- The three leads are called bipolar because for each lead the electrocardiogram is recorded from any two electrodes and the third electrode is not connected.
- The R-wave of the ECG is positive in all three bipolar limb leads, however Lead-II produces greatest R-wave potential.
- The R-wave amplitude of Lead II is equal to the sum of R wave amplitudes of Lead I and Lead III.

# The Electrocardiogram (ECG)

## The standard Bipolar Limb Lead I

- Lead I is the first of three standard limb leads (I, II, III).
- Limb leads measure cardiac depolarization in the frontal (coronal) plane.
- The negative electrode is connected to the RIGHT ARM (RA).
- The positive electrode is connected to the LEFT ARM (LA).
- The axis is  $0^{\circ}$  degrees.
- When an action potential starts on the right and proceeds toward the left side of the heart, a positive inflection will be seen in lead one. This holds true for all leads. Whenever a current proceeds toward a positive electrode, an upright inflection is seen on the EKG tracing.

# The Electrocardiogram (ECG)

## The standard Bipolar Limb Lead II

- Lead II is used alone quite frequently.
- Normal rhythms present with a prominent P-wave and a tall QRS complex.
- The negative electrode is connected to the RIGHT ARM (RA).
- The positive electrode is connected to the LEFT LEG (LL).
- The axis is  $+60^{\circ}$  degrees.
- In all the limb leads, the electrodes may be positioned close to the torso. For convenience, they are often placed at the shoulders and hips.

# The Electrocardiogram (ECG)

## The standard Bipolar Limb Lead III

- Lead III is the last of the three standard limb leads.
- The negative electrode is connected to the LEFT ARM (LA).
- The positive electrode is connected to the LEFT LEG (LL).
- The axis is  $120^{\circ}$  degrees.

# The Electrocardiogram (ECG)

## The Augmented (Unipolar) Limb Leads

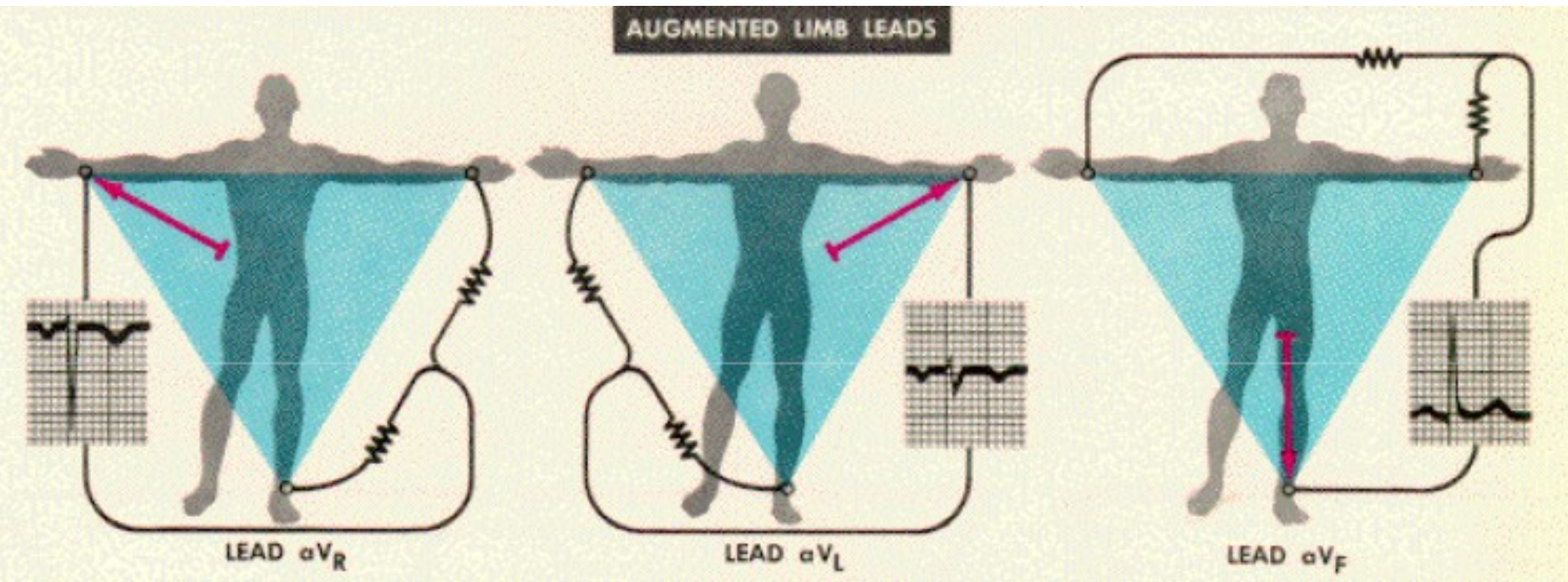

# The Electrocardiogram (ECG)

## The Augmented (Unipolar) Limb Leads

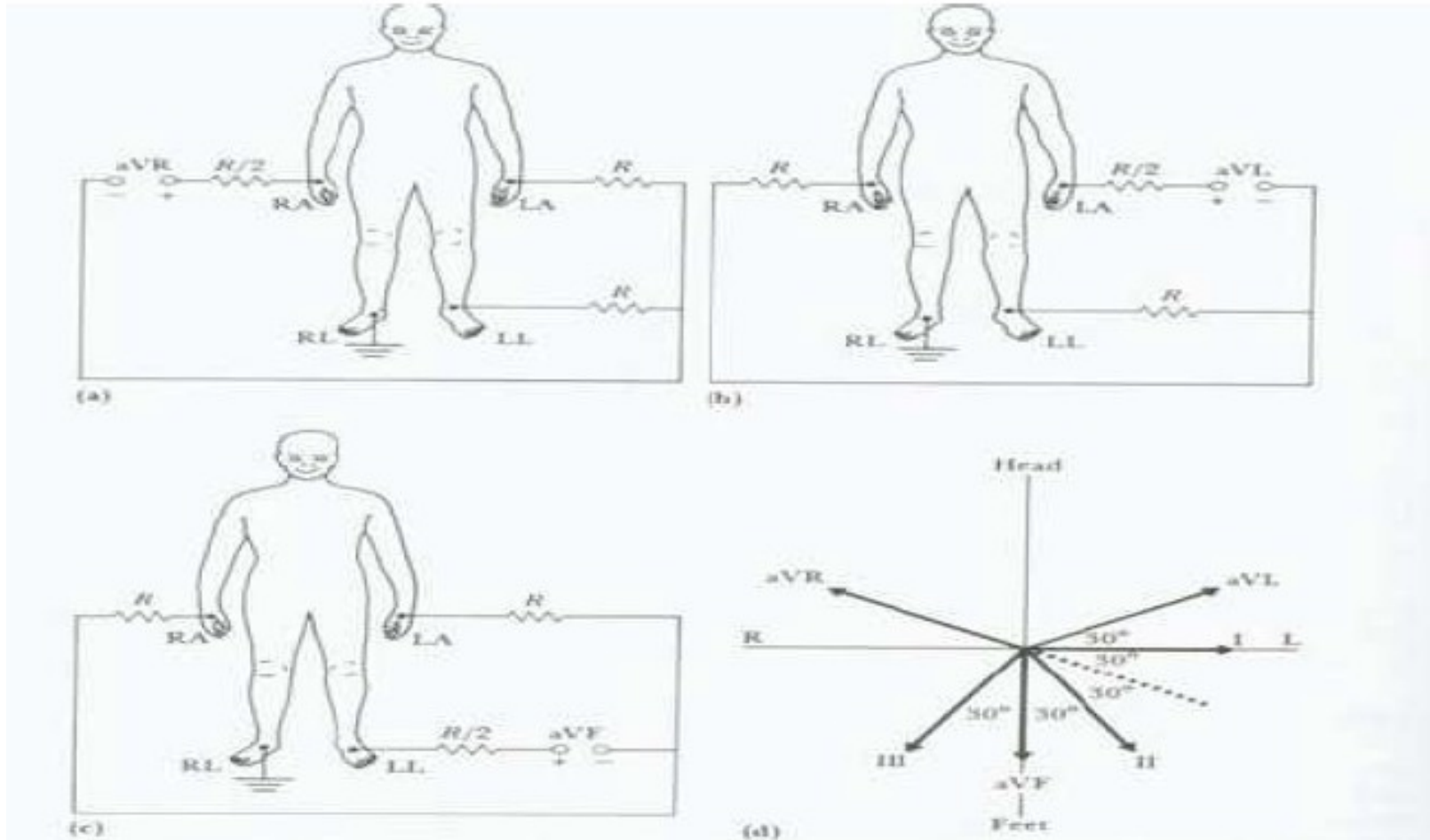

**Figure 6.5** (a), (b), (c) Connections of electrodes for the three augmented limb leads. (d) Vector diagram showing standard and augmented lead-vector directions in the frontal plane.

# The Electrocardiogram (ECG)

## The Augmented (Unipolar) Limb Leads

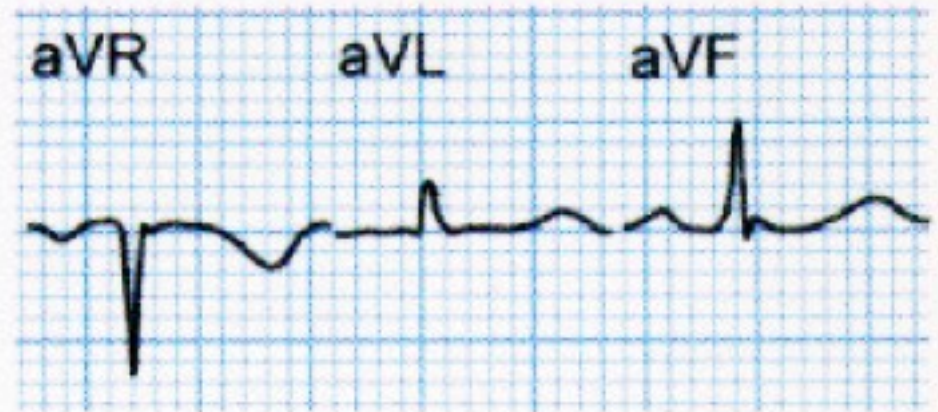
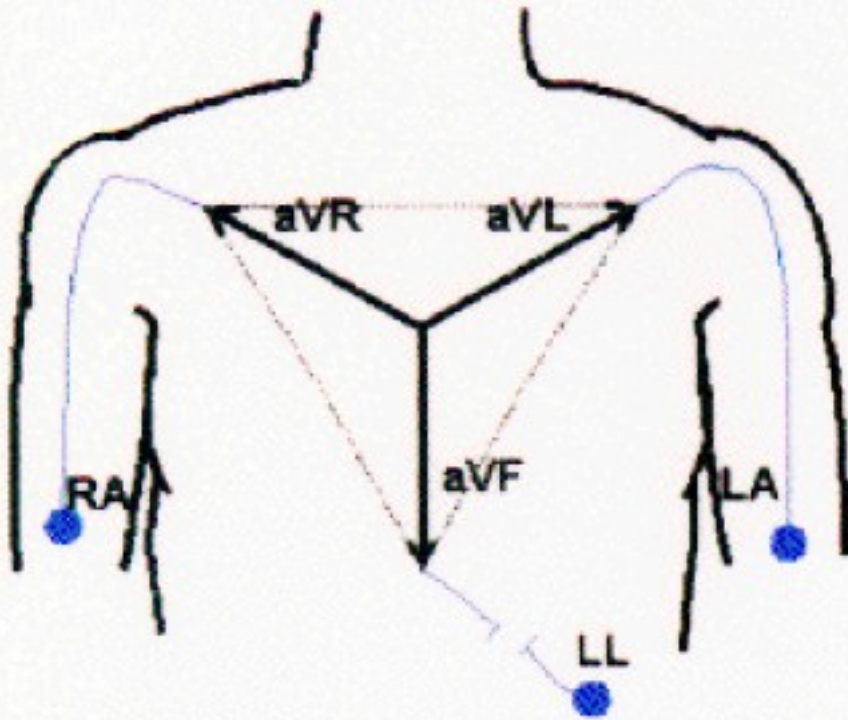

# The Electrocardiogram (ECG)

## The Augmented (Unipolar) Limb Leads

- Three additional leads are used for frontal plane measurements.
- These are the measurements at the specific electrodes, with respect to a reference electrode.
- One commonly used reference electrode is the Wilson Central Terminal (WCT), obtained through a resistive network, combining limb electrodes.
- The new set of leads obtained by combining the standard limb electrodes to the Wilson terminal form the augmented leads.
- These leads provide additional vector views of cardiac depolarization in the frontal plane.
- Unlike leads I, II, III, the augmented leads utilize WCT, a central negative terminal.
- This virtual "electrode" is calculated by the EKG computer to measure vectors originating roughly at the center of the heart.
- Note that the voltage at Wilson's terminal is zero.



# The Electrocardiogram (ECG)

## The Augmented (Unipolar) Limb Leads

Wilson Central Terminal (WCT)

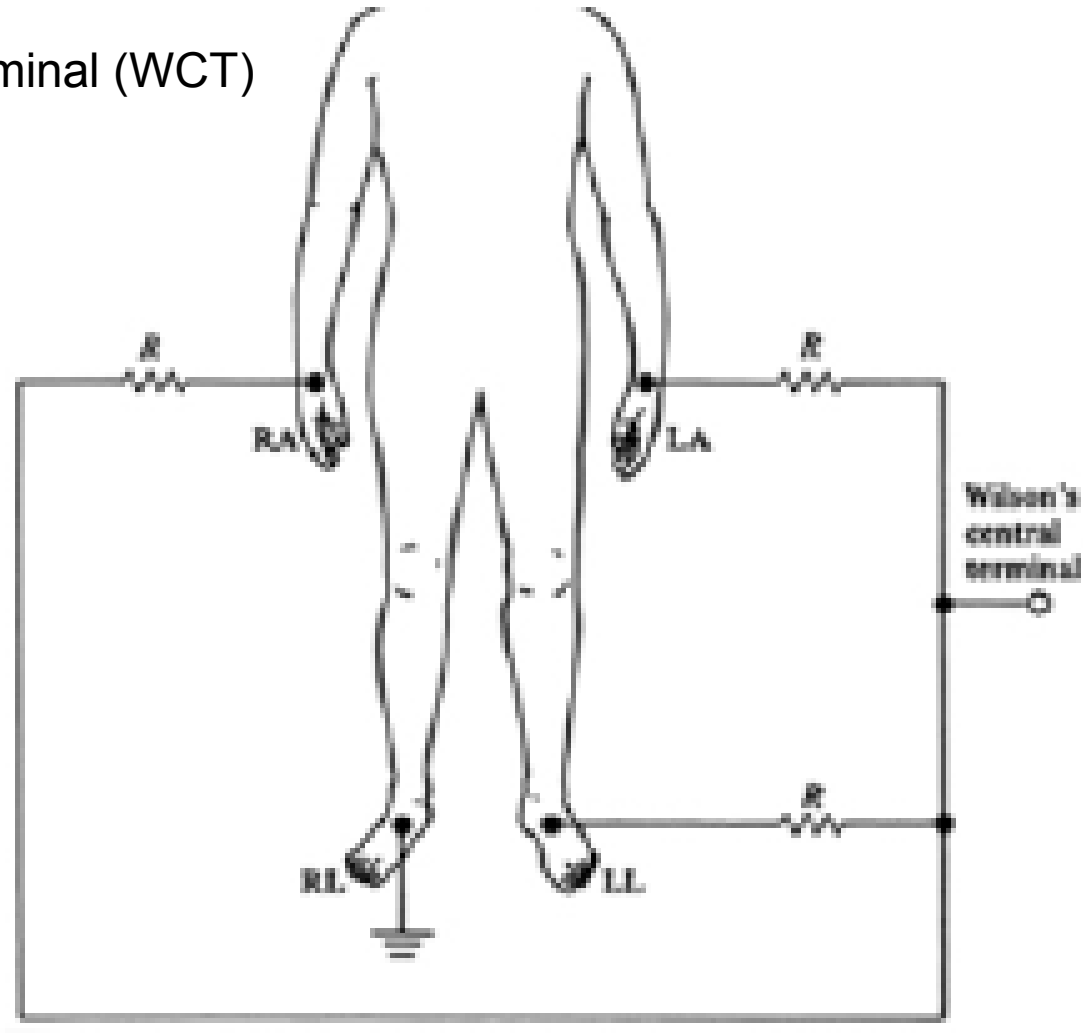

# The Electrocardiogram (ECG)

## The Augmented (Unipolar) Limb Leads

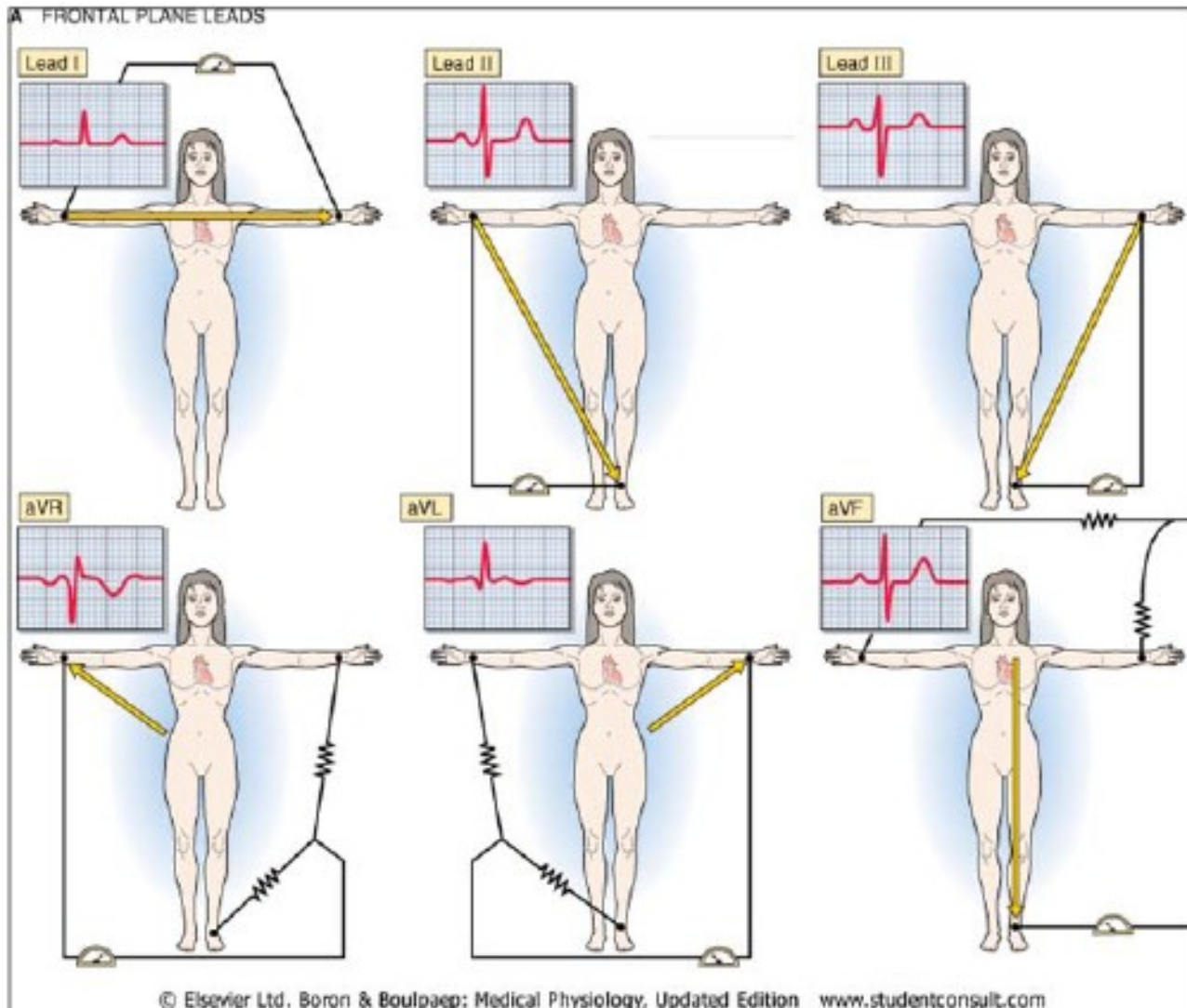

# The Electrocardiogram (ECG)

## The Augmented (Unipolar) Limb Leads

The 3 augmented leads (aVR, aVL, aVF) compare one limb electrode to the average of the other two electrodes.

# The Electrocardiogram (ECG)

## The Augmented (Unipolar) Limb Leads

- Augmented Lead (RIGHT) **avR**.
- The negative electrode is the central terminal.
- The positive electrode is connected to the RIGHT ARM (RA).
- The axis is  $-150^{\circ}$  degrees.

# The Electrocardiogram (ECG)

## The Augmented (Unipolar) Limb Leads

- Augmented Lead (LEFT) **avL**.
- The negative electrode is the central terminal.
- The positive electrode is connected to the LEFT ARM (LA).
- The axis is  $-30^{\circ}$  degrees.

# The Electrocardiogram (ECG)

## The Augmented (Unipolar) Limb Leads

- Augmented Lead (FEET) **avF**.
- The negative electrode is the central terminal.
- The positive electrode is connected to the LEFT LEG (LL).
- The axis is  $+90^\circ$  degrees.

# The Electrocardiogram (ECG)

## The Einthoven Triangle

A EINTHOVEN'S TRIANGLE

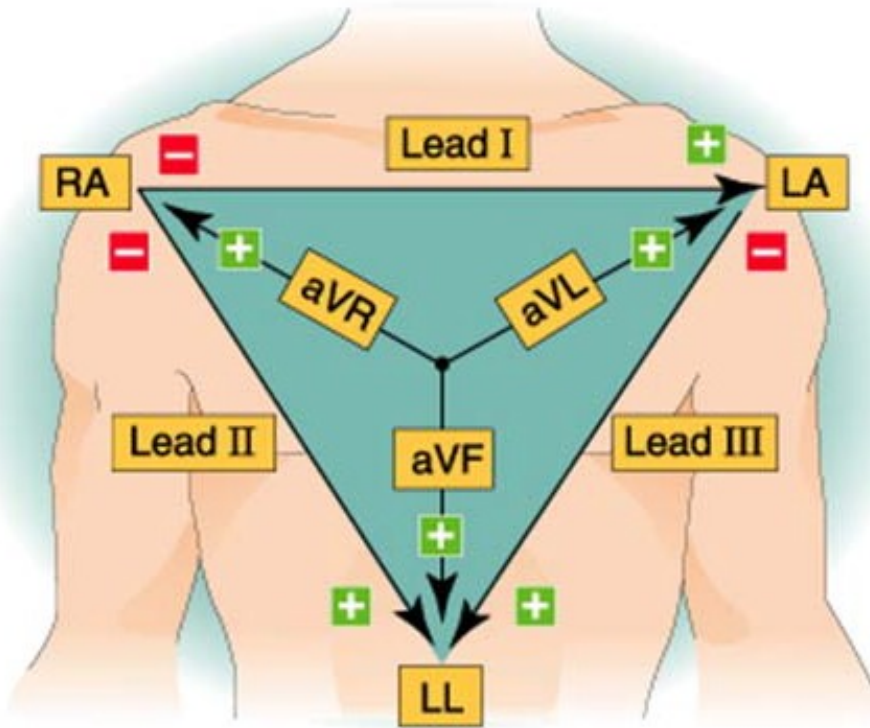

B CIRCLE OF AXES

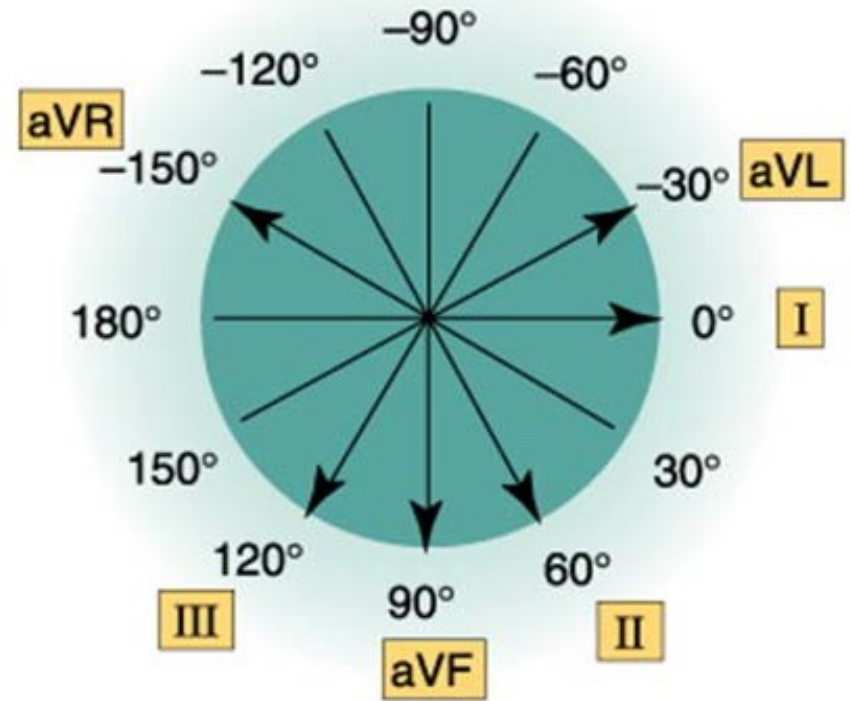

# The Electrocardiogram (ECG)

## The Einthoven Triangle

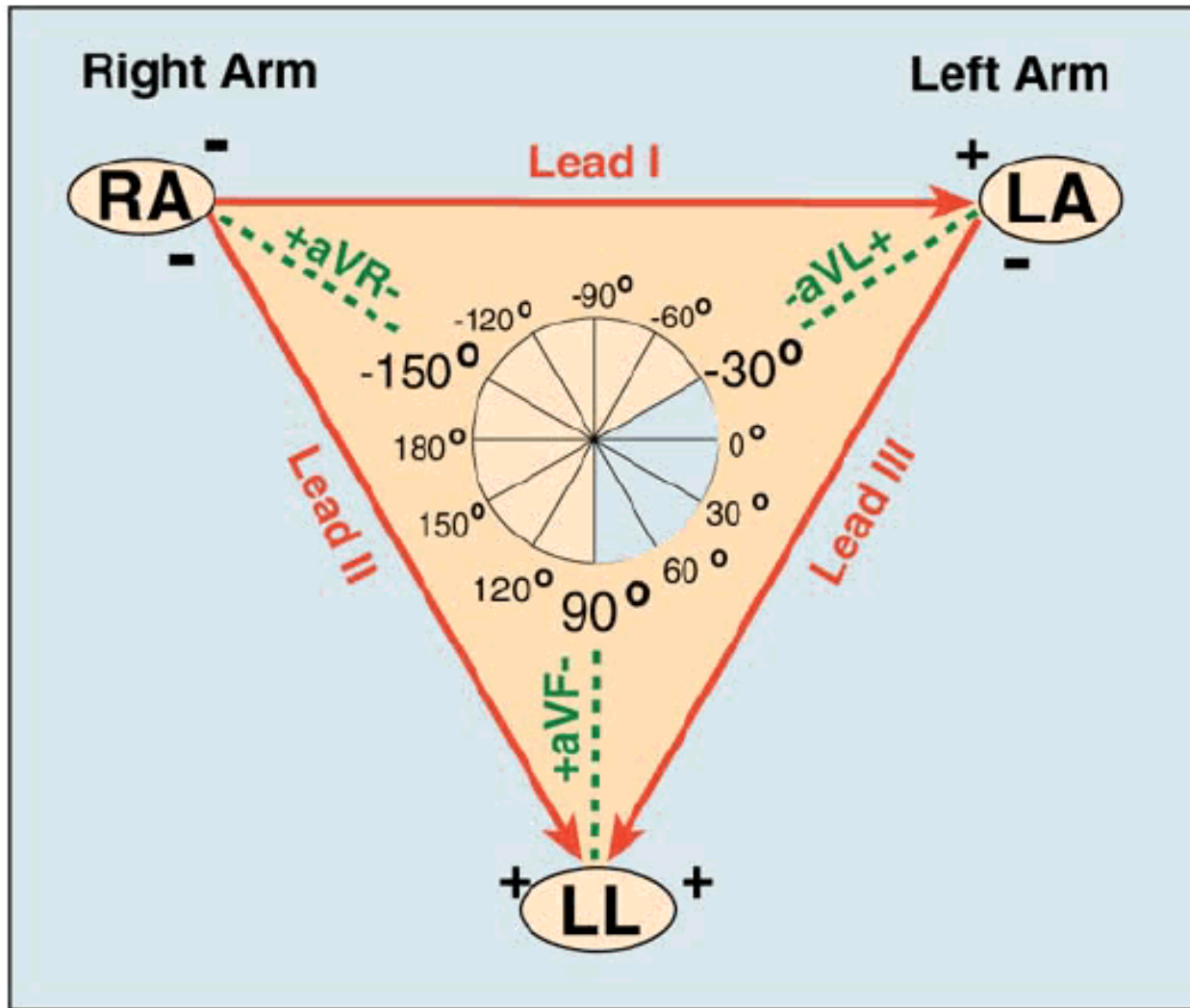



# The Electrocardiogram (ECG)

## The Precordial Unipolar Chest Leads

- V1: Fourth intercostal space at right sternal margin..
- V2: Fourth intercostal space at left sternal margin.
- V3: Midway between V2 and V4.
- V4: Fifth intercostal space at mid-clavicular line.
- V5: Same level as V4, on anterior axillary line.
- V6: Same level as V4, on mid axillary line.

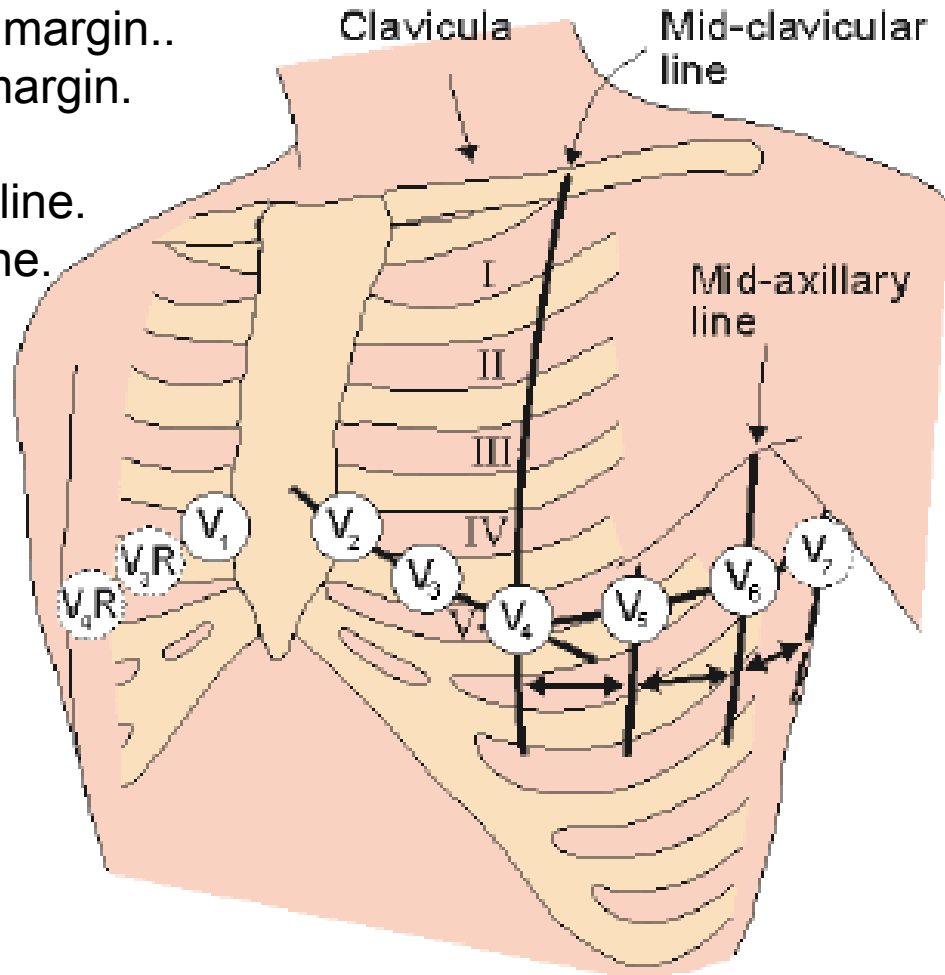
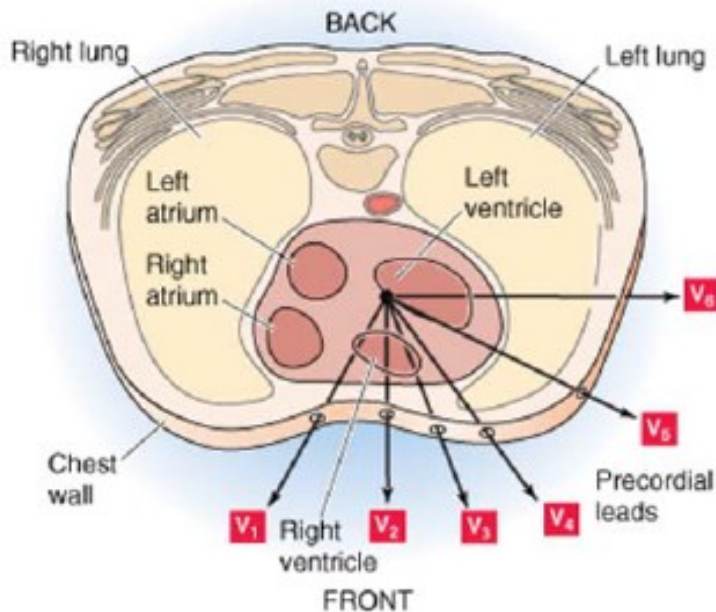

# The Electrocardiogram (ECG)

## The Precordial Unipolar Chest Leads

- Additional set of six leads, placed on the chest, also known as the **precordial leads**.
- These too are unipolar, that is they measure the potential with respect to Wilson Central Terminal (WCT).
- The main reason for recording all 12 leads is that it enhances pattern recognition.
- This combination of leads gives the clinician an opportunity to compare the projections of the resultant vectors in two orthogonal planes and at different angles.

# The Electrocardiogram (ECG)

## The Precordial Unipolar Chest Leads

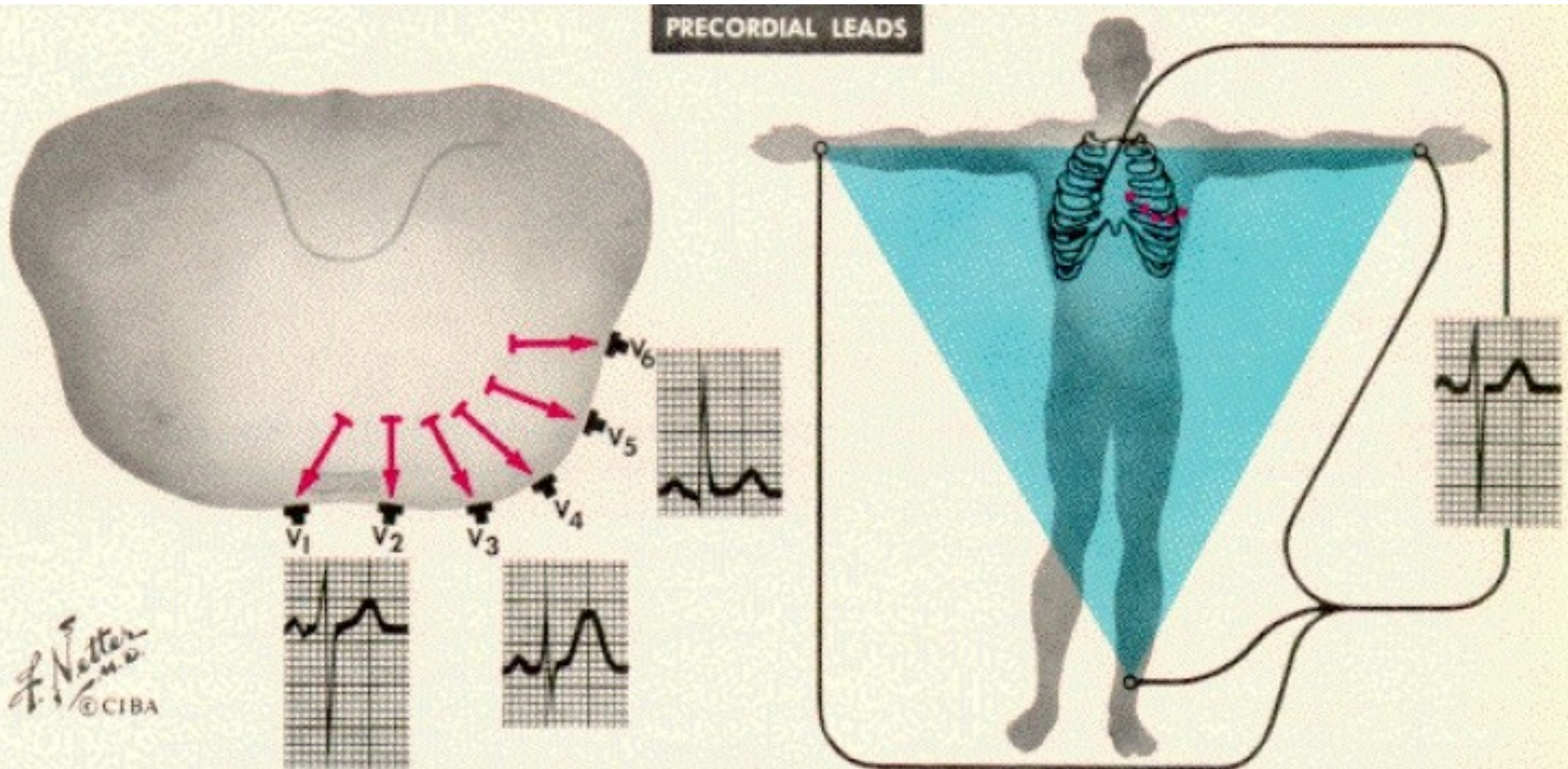

*F. Netter M.D.*  
© CIBA

WHEN CURRENT FLOWS TOWARD RED ARROWHEADS, UPWARD DEFLECTION OCCURS IN ECG  
WHEN CURRENT FLOWS AWAY FROM RED ARROWHEADS, DOWNWARD DEFLECTION OCCURS IN ECG  
WHEN CURRENT FLOWS PERPENDICULAR TO RED ARROWS, NO DEFLECTION OR BIPHASIC DEFLECTION OCCURS

# The Electrocardiogram (ECG)

## The Precordial Unipolar Chest Leads

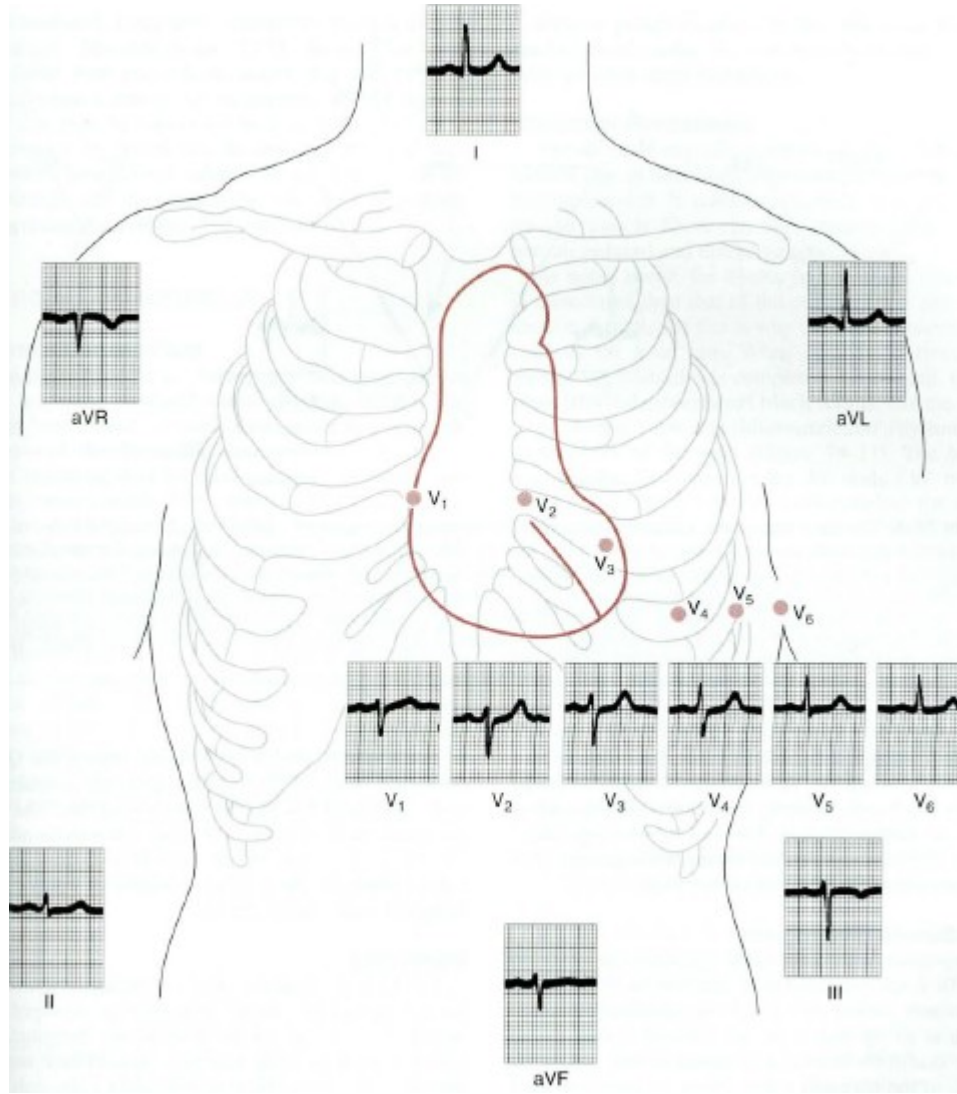

# Electrocardiography

**Electrocardiography** (abb. ECG or EKG)- a standard noninvasive procedure for recording electrical potentials of the heart. The record (electrocardiogram), consists of waves that relate to the electrical activity of the heart during each beat. Results - printed on paper or displayed on monitor.



Electrocardiogram (ECG)



# Electrocardiography

## Old & Modern ECG System



Electrocardiogram  
(ECG)



# Electrocardiography

## Types of ECG Recorders

1. Single Channel ECG Recorder.
2. Three Channel ECG Recorder.
3. Vector Electrocardiograph.
4. Electrocardiograph System for Stress Testing.
5. Electrocardiograph System for Computer Processing.
6. Continuous ECG recorder (Holter Recorder).

# The Electrocardiogram (ECG)

## Cardiac Rhythms - Normal & Abnormal

### Normal

- Heart rate is about 70 beats per minute (bpm)
- Bradycardia: slower than normal (during sleep)
- Tachycardia: higher than normal (during exercise, emotional episodes, fever, fright)

### Abnormal

- Idioventricular heart rate is about 30 - 45 bpm (ventricles and atria beat independently)
- Disease can alter the conducting pathways (e.g., rheumatic heart disease and viral infections)
- Infarction (loss of blood supply and muscle death) can alter the heart muscle conducting pattern



# Heart Block (dysfunctional His Bundle)

## (a) Complete heart block.

Cells in the AV node are dead and activity cannot pass from atria to ventricles. Atria and ventricles beat independently, ventricles being driven by an ectopic (other-than-normal) pacemaker.

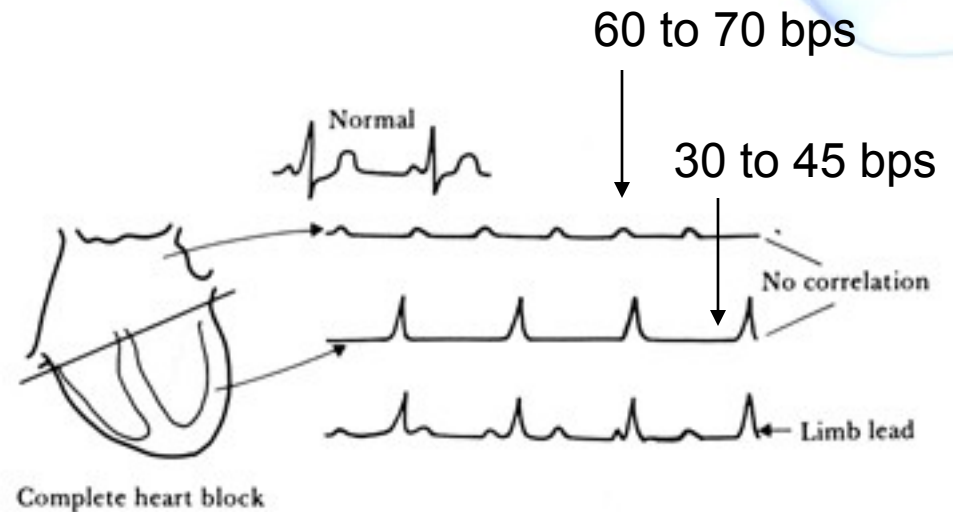

(a)

## (b) First-degree heart block.

AV block wherein the node is diseased (examples include rheumatic heart disease and viral infections of the heart). Although each wave from the atria reaches the ventricles, the AV nodal delay is greatly increased.

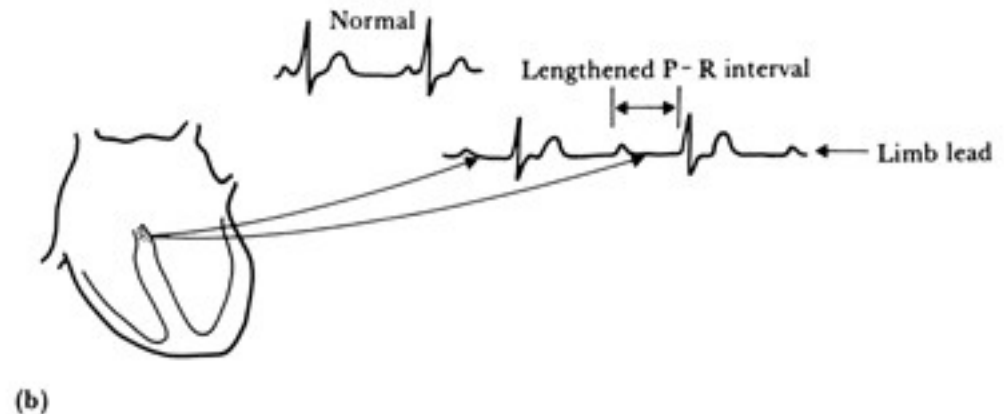

# Cardiac Arrhythmias

A portion of the myocardium sometimes becomes “irritable” and discharge independently.

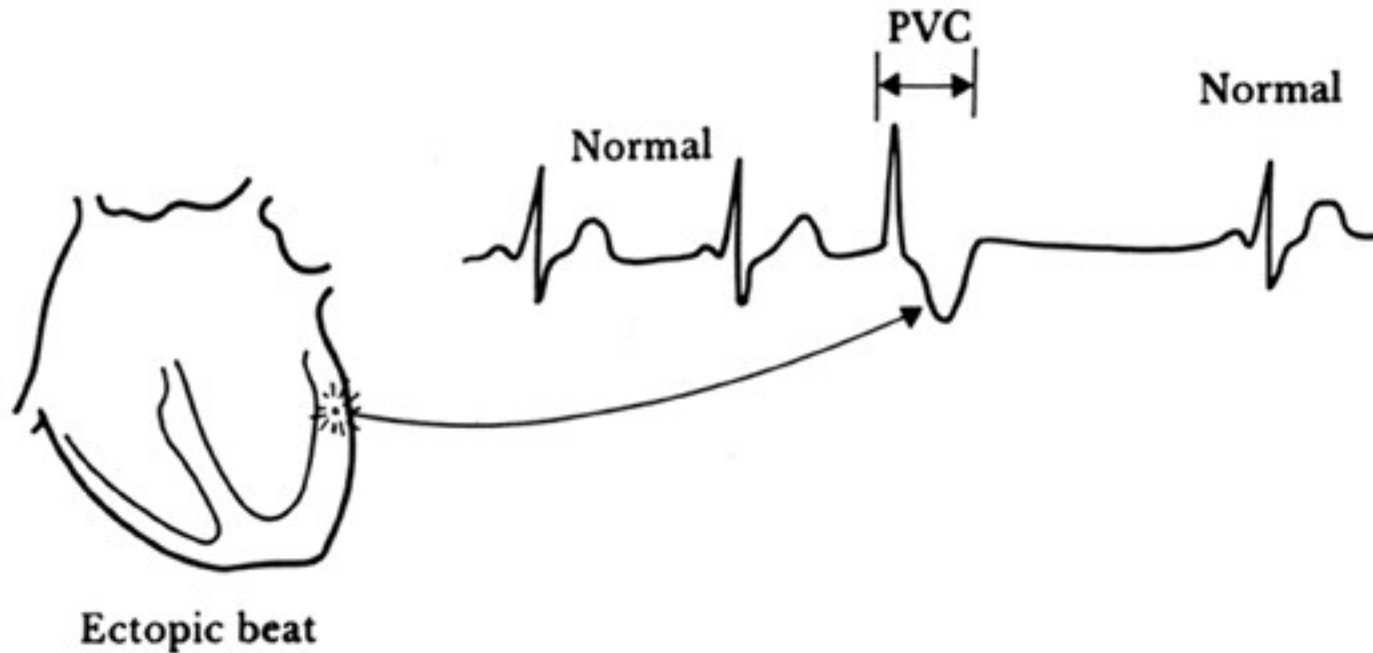

**Figure 4.18 Normal ECG followed by an ectopic beat** An irritable focus, or *ectopic pacemaker*, within the ventricle or specialized conduction system may discharge, producing an extra beat, or *extrasystole*, that interrupts the normal rhythm. This extrasystole is also referred to as a premature ventricular contraction (PVC).

# Cardiac Arrhythmias

**Figure 4.19** (a) Paroxysmal tachycardia. An ectopic focus may repetitively discharge at a rapid regular rate for minutes, hours, or even days. (B) Atrial flutter. The atria begin a very rapid, perfectly regular "flapping" movement, beating at rates of 200 to 300 beats/min.

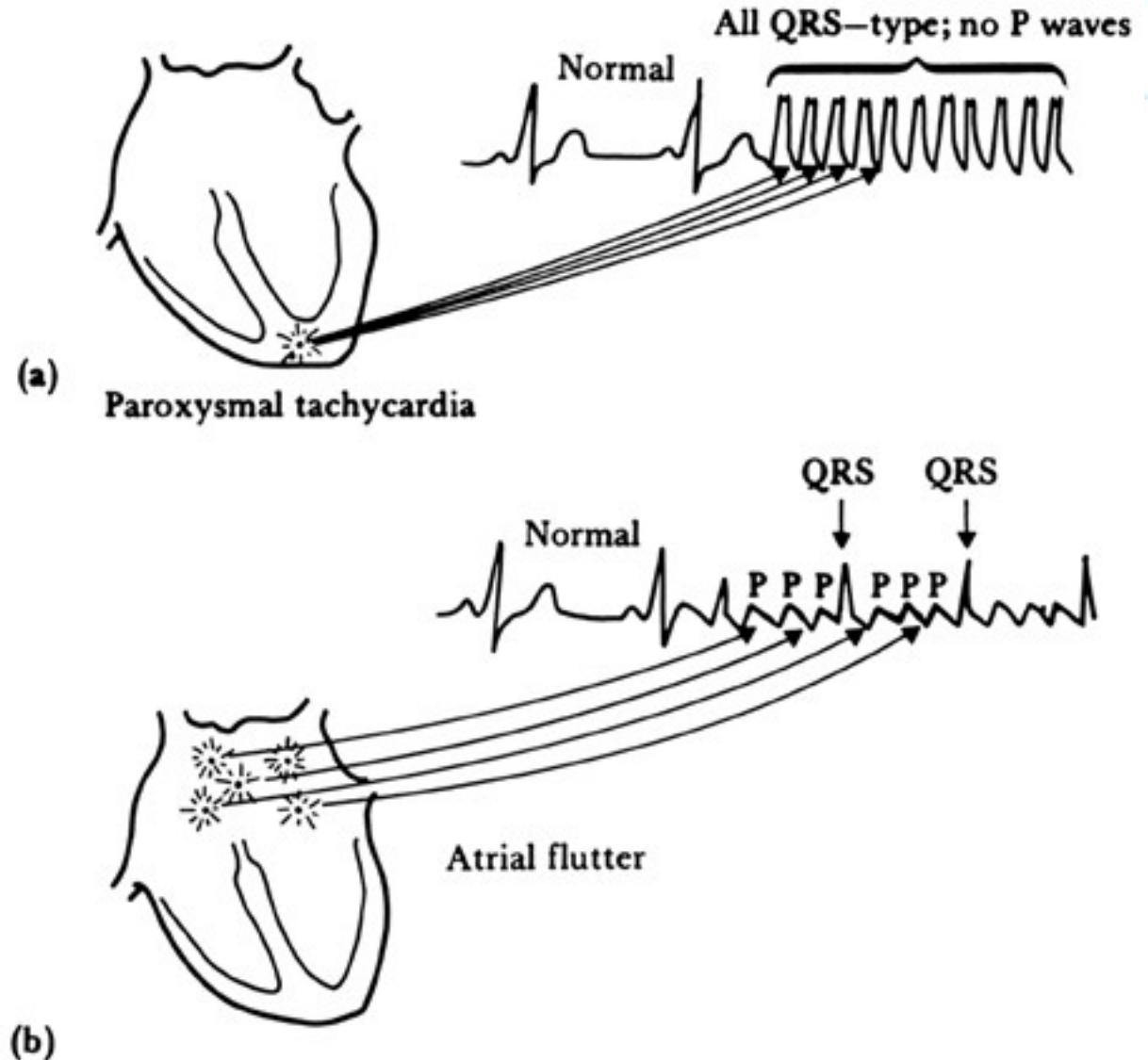

# Cardiac Arrhythmias

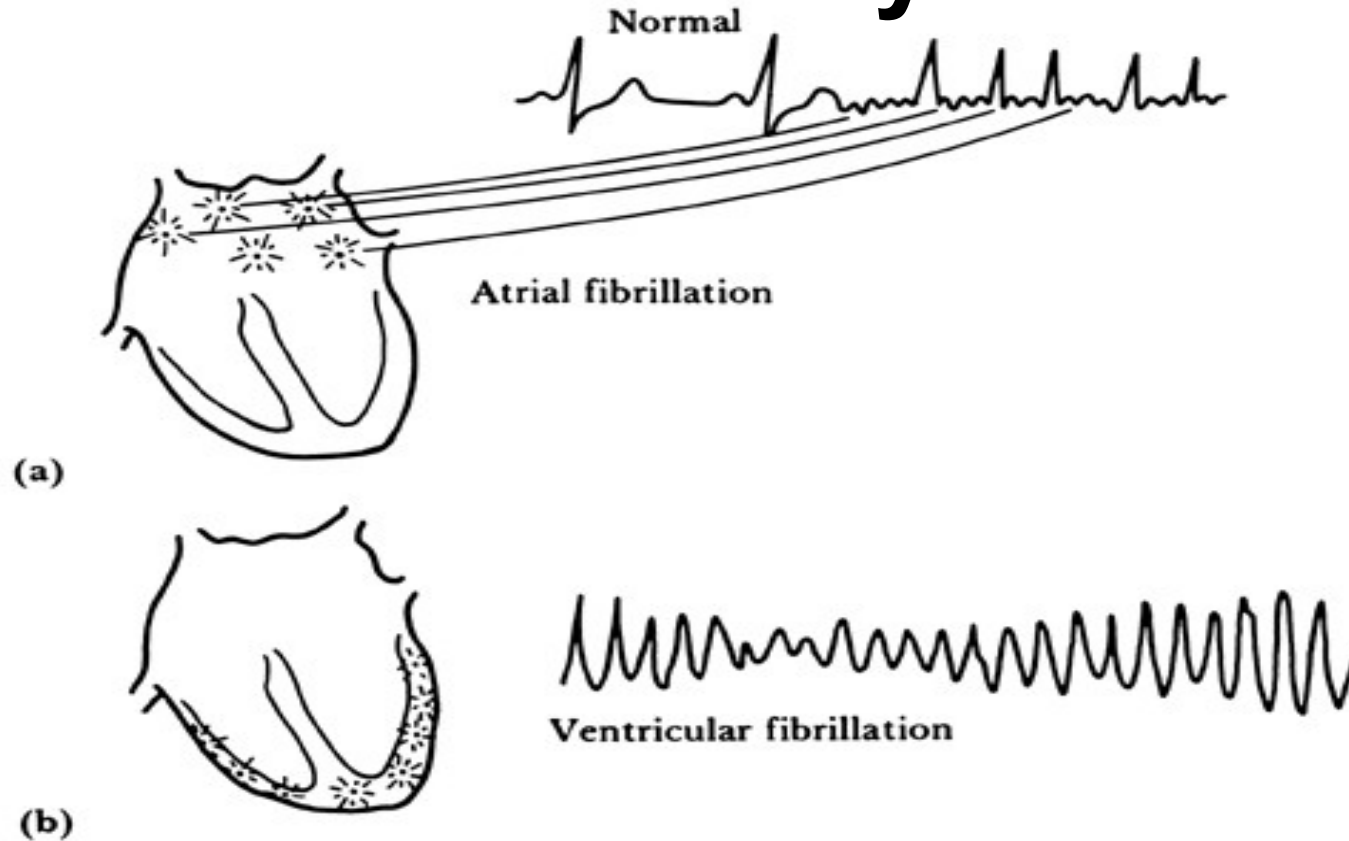

**Figure 4.20** (a) Atrial fibrillation. The atria stop their regular beat and begin a feeble, uncoordinated twitching. Concomitantly, low-amplitude, irregular waves appear in the ECG, as shown. This type of recording can be clearly distinguished from the very regular ECG waveform containing atrial flutter. (b) Ventricular fibrillation. Mechanically the ventricles twitch in a feeble, uncoordinated fashion with no blood being pumped from the heart. The ECG is likewise very uncoordinated, as shown

# Alteration of Potential Waveforms in Ischemia

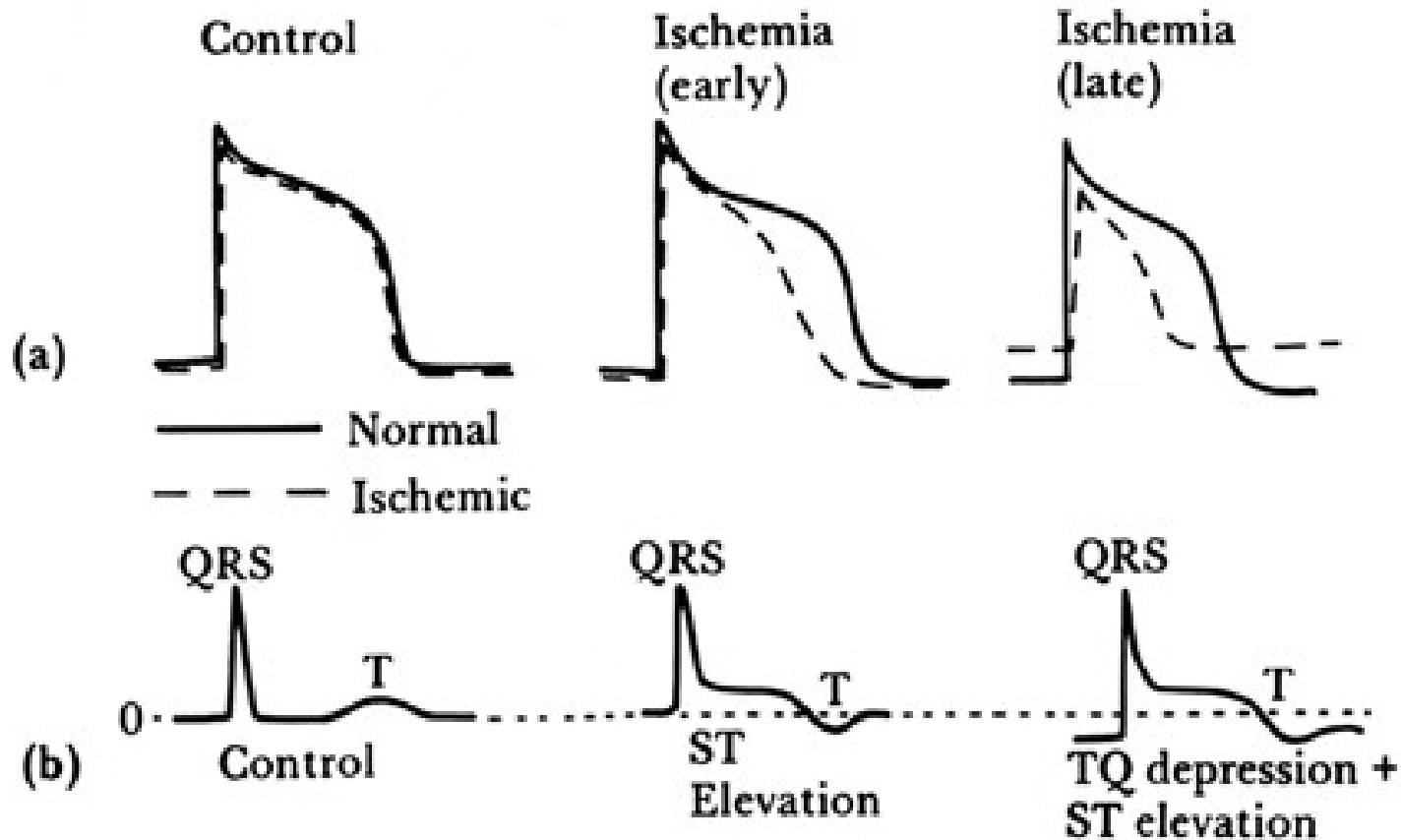

**Figure 4.21** (a) Action potentials recorded from normal (solid lines) and ischemic (dashed lines) myocardium in a dog. Control is before coronary occlusion. (b) During the control period prior to coronary occlusion, there is no ECG S-T segment shift; after ischemia, there is such a shift.

# Electrocardiograph

- ECG machines can run at 50 or 25 mm/sec.
- Major grid lines are 5 mm apart, at standard 25 mm/s, 5 mm corresponds to .20 seconds.
- Minor lines are 1 mm apart, at standard 25 mm/s, 1 mm corresponds to .04 seconds.
- Voltage is measured on vertical axis.
- Standard calibration is 0.1 mV per mm of deflection.
- When myocardial muscle is completely polarized or depolarized, the ECG will not record any electrical potential but rather a flat line, isoelectric line.

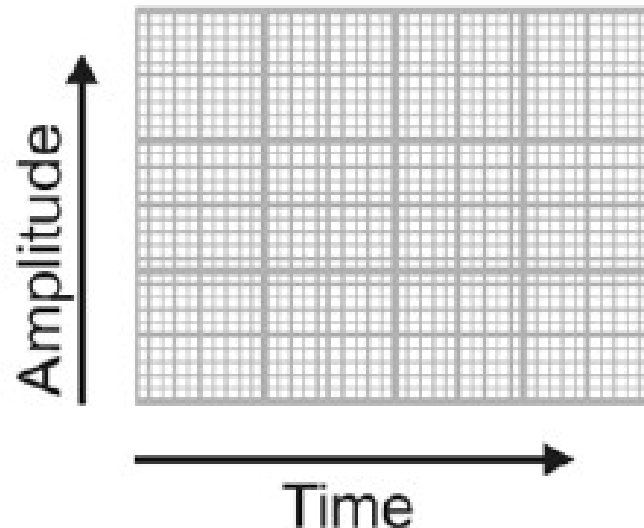

# Electrocardiograph

ECG Signals have two components:

## 1. ECG Waveform

- 0.05 Hz to 150 Hz bandwidth per Medical Standards
- Average R Wave Amplitude is 1.8 mV
- Some waveforms can be as big as 10 mV p-p.
- T wave is only a few micro volts in amplitude

## 2. Pacing Artifact

- Medical Standards require 2 mV and 200  $\mu$ s detection
- Average pulse is 1 mV and 500  $\mu$ s but can be much smaller

# Electrocardiograph

## Typical ECG waveforms

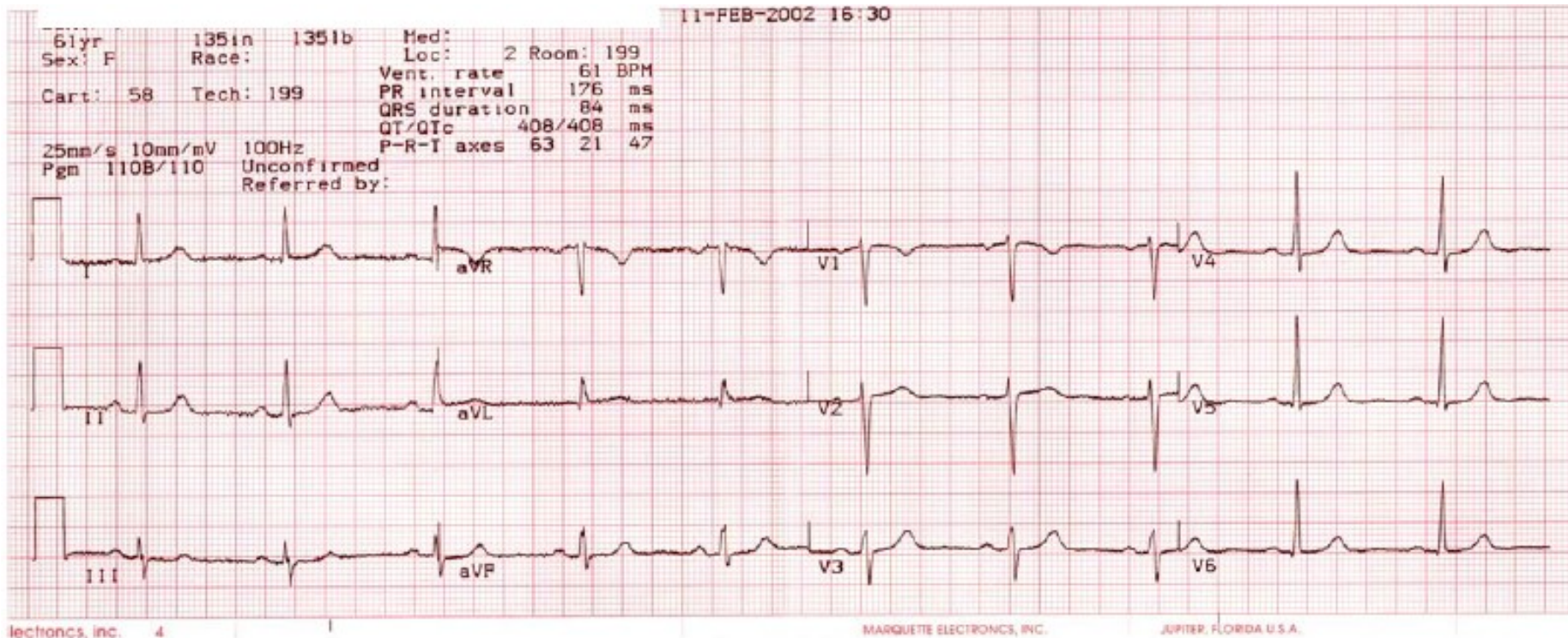



# Electrocardiograph

## Block Diagram of ECG System

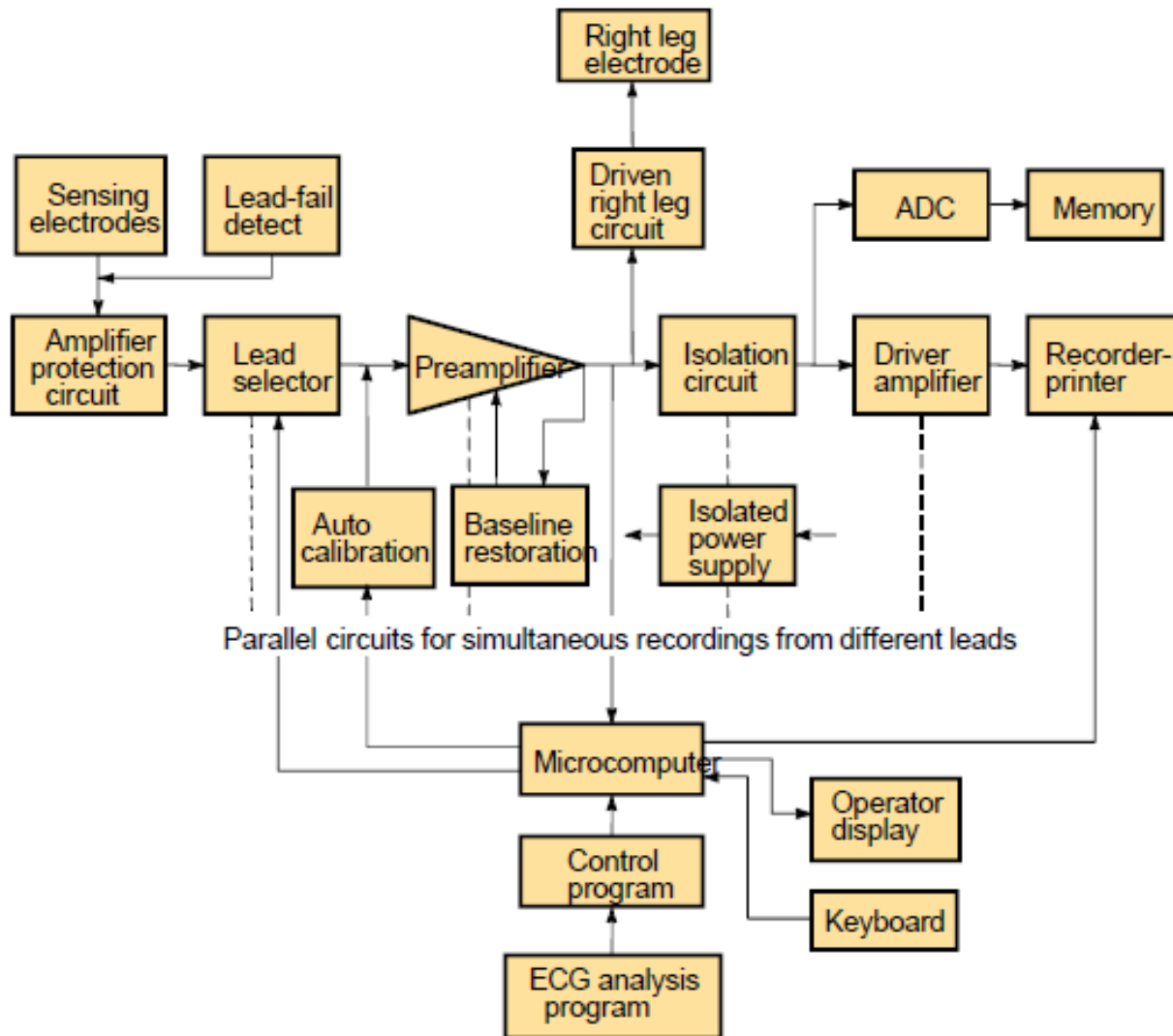

# Electrocardiograph

## Frequent Problems in ECG System

### Frequency distortion

- High-frequency loss rounds the sharp edges of the QRS complex.
- Low-frequency loss can distort the baseline (no longer horizontal) or cause monophasic waveforms to appear biphasic.

### Saturation/cutoff distortion

- Combination of input amplitude & offset voltage drives amplifier into saturation
- Positive case: clips off the top of the R wave
- Negative case: clips off the Q, S, P and T waves

# Electrocardiograph

## Frequent Problems in ECG System

### Ground loops

- Patients are connected to multiple pieces of equipment; each has a ground (power line or common room ground wire).
- If more than one instrument has a ground electrode connected to the patient, a ground loop exists. Power line ground can be different for each item of equipment, sending current through the patient and introducing common-mode noise.

### Open lead wires

- Can be detected by impedance monitoring.

# Electrocardiograph

## ECG Artefacts

Coupling of 50 Hz Power Line Noise



# Electrocardiograph

## ECG Artefacts

Coupling of Electromyogram (EMG) Noise

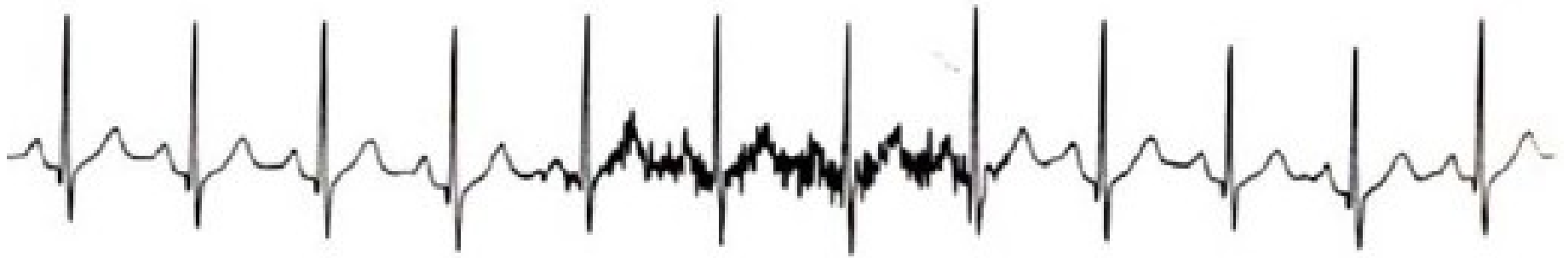

# Cardio Tachometer

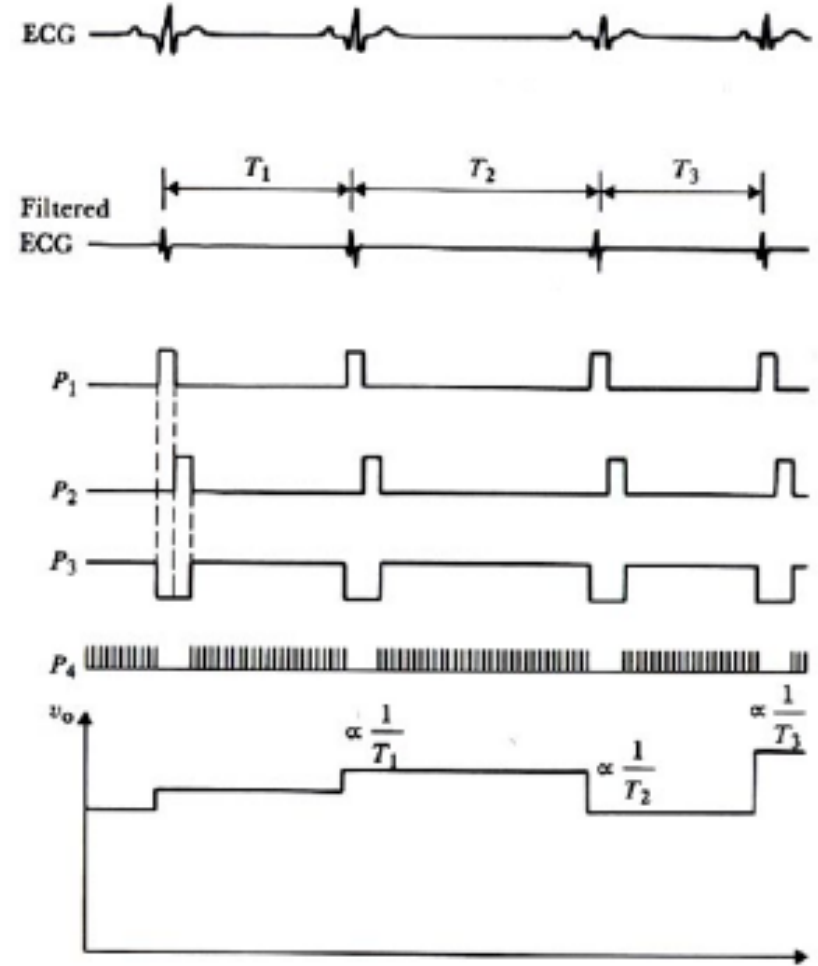
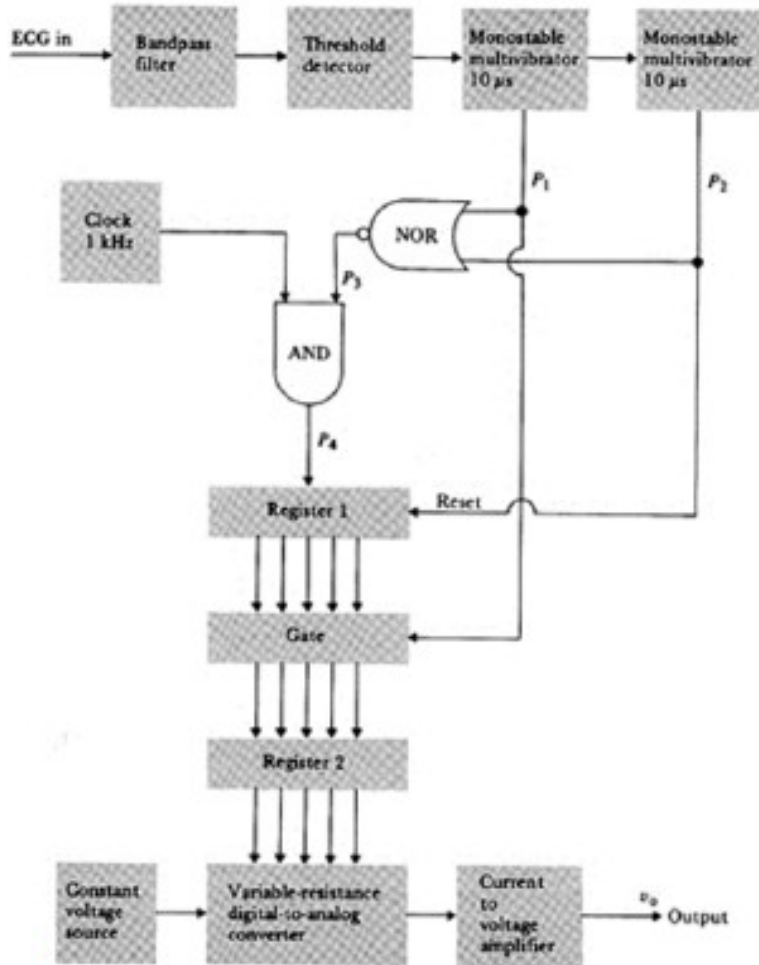

# ECG Telemetry System

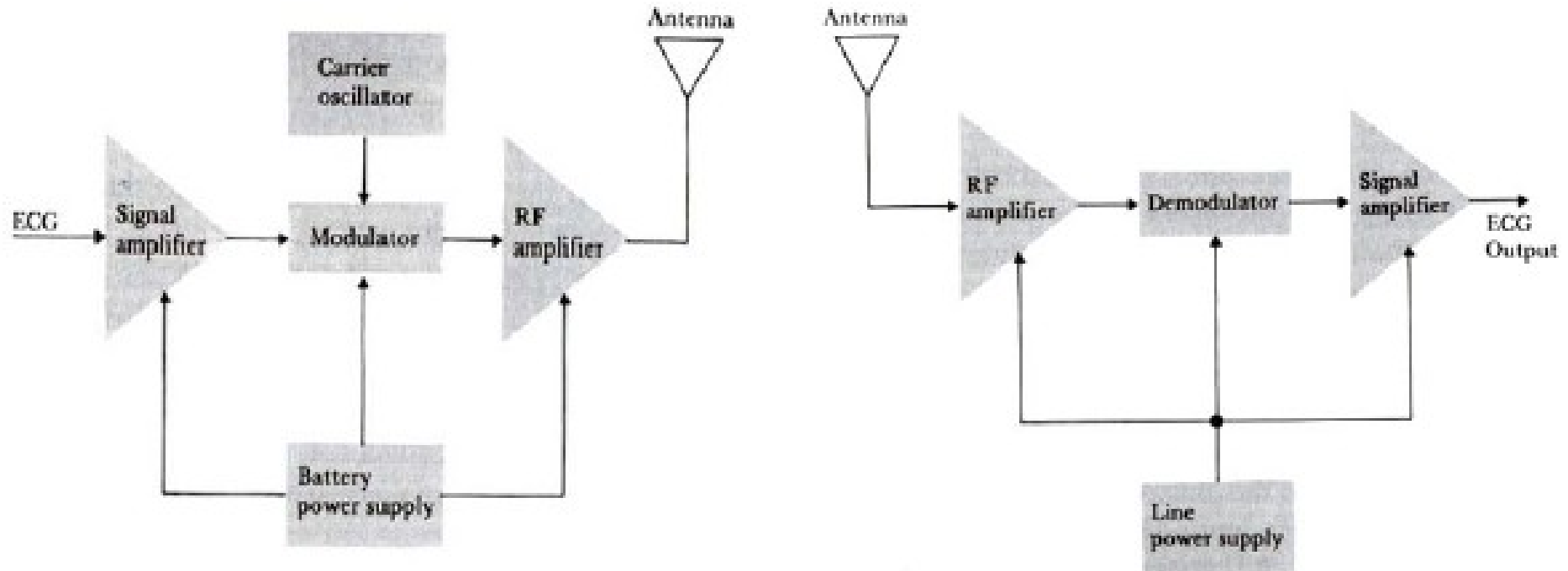



**Questions?**